

A photograph of industrial machinery, likely a robotic assembly line, featuring several FASTUS sensors. The sensors are mounted on vertical metal supports and are connected to various cables and hoses. The background is blurred, showing more of the factory environment. The FASTUS logo is prominently displayed in the top left corner.

**FASTUS**

**Optimal solutions for the connections of  
pressure sensors and flow sensors**

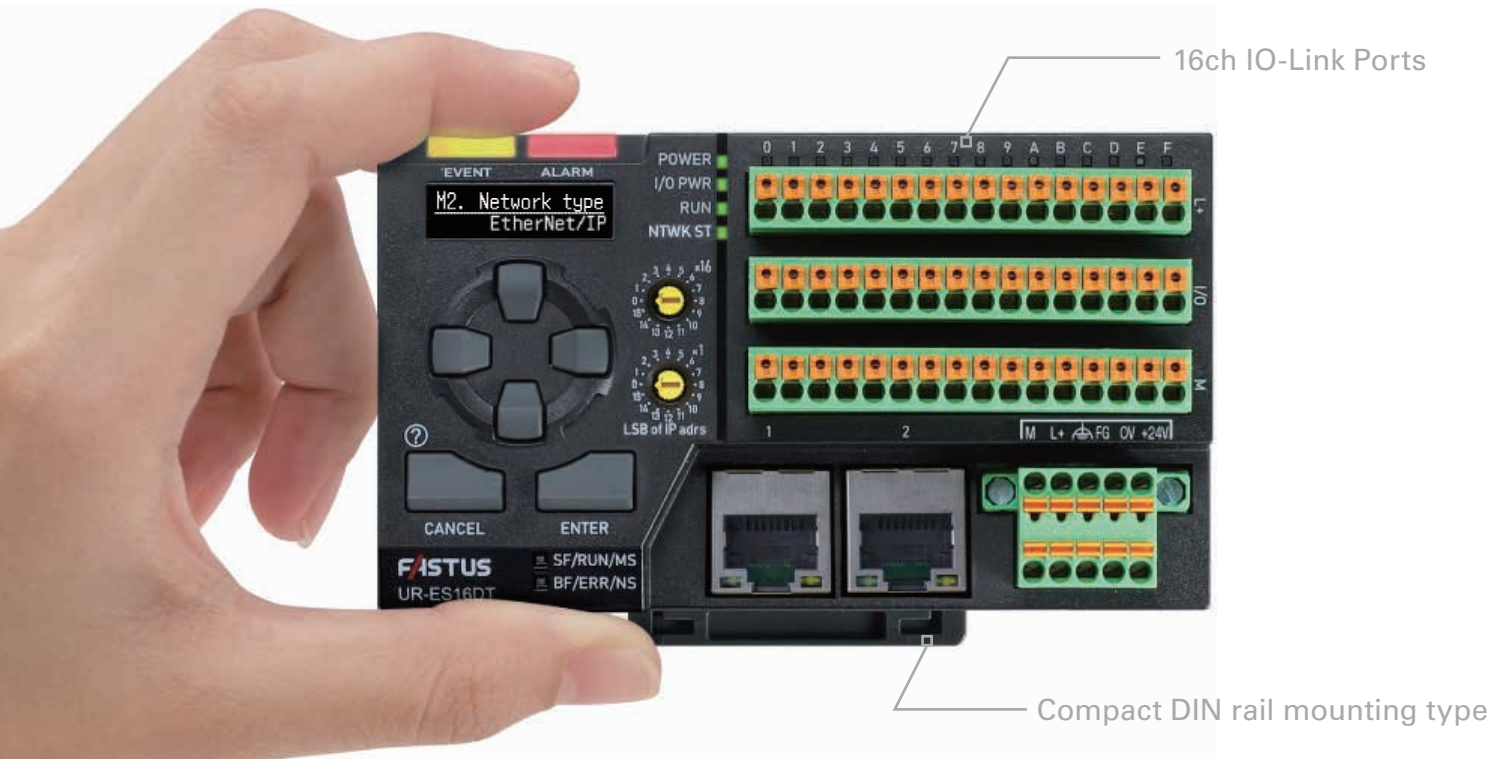

 **IO-Link** Master

UR-MS16DT / UR-ES16DT

OPTEx FA CO., LTD

# 01

## UseCase



### Before

During the initial setup of FPD manufacturing equipment, many man-hours were required to fine-tune and calibrate analog flow sensors due to convert errors that occur during A/D conversion.

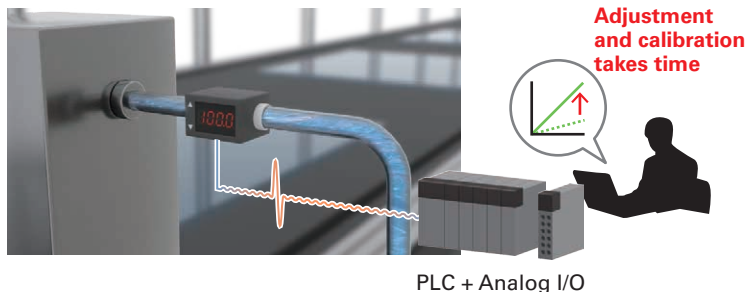

### After

Since IO-Link handles measured values as digital signals, there is no need for fine-tuning or calibration of errors that occur during A/D convert. Especially, value zero can be easily obtained.

Accurate  
measurement

No calibration  
required

Reduced  
man-hours

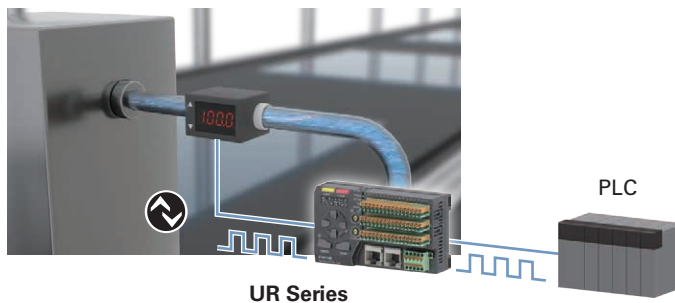

# Accurate data collection

Since IO-Link handles sensor measurement values as digital signals, there is no change in values due to noise, and **the measured values can be accurately collected.**

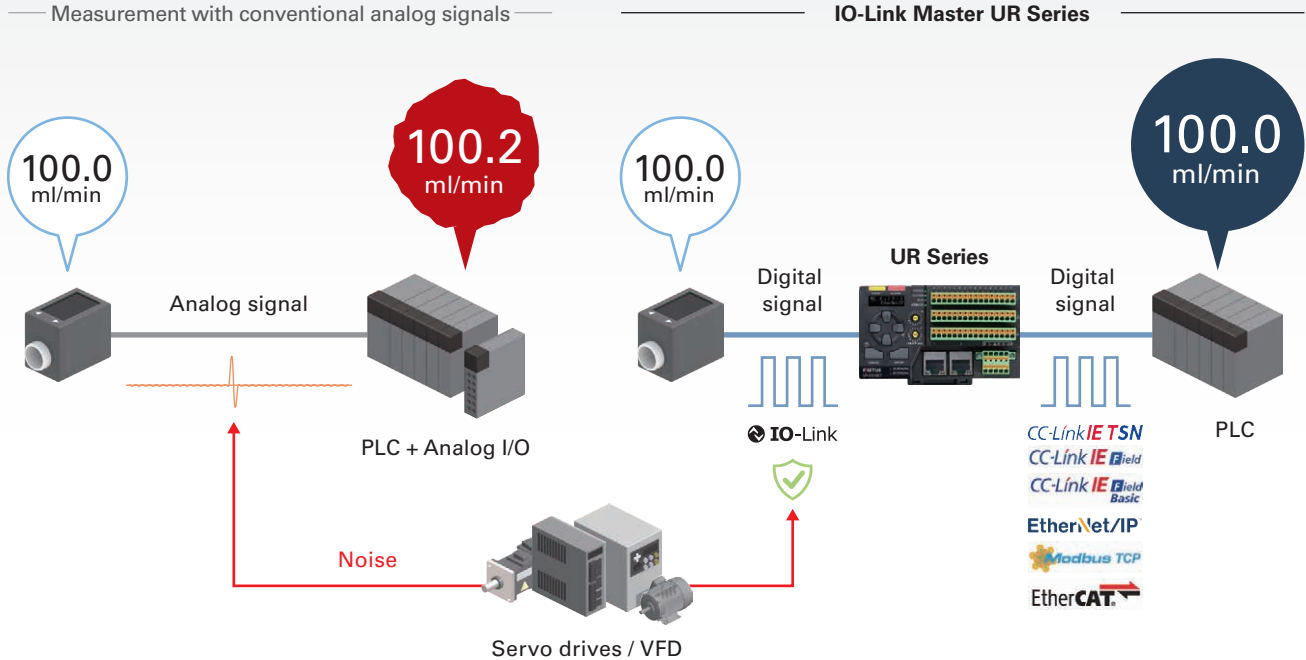

# 02

## UseCase

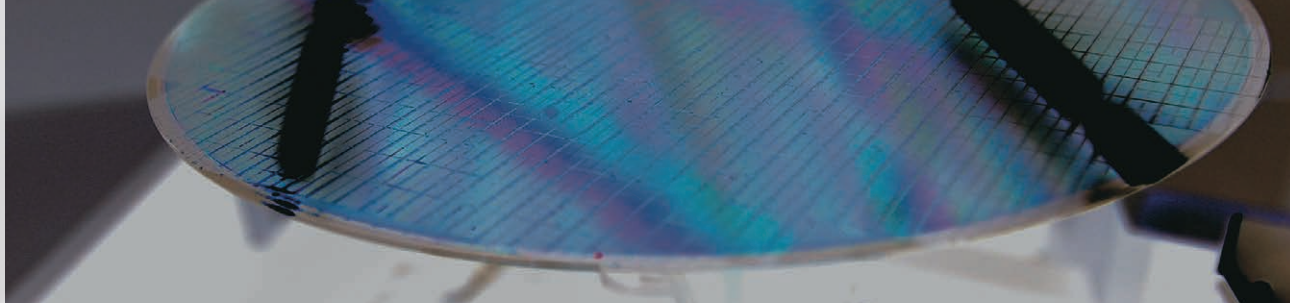

### Before

Semiconductor manufacturing equipment uses multiple pressure or flow sensors, and settings using the displays and switches on the sensor itself have been prone to setting errors or unintentional setting omission.



### After

With IO-Link, there is no need to use the sensor's small display or switches, and settings can be made from the host network, leading to a significant reduction in setup time and configuration errors.

**No individual parameter settings required**

**Reduction of manual configuration errors**

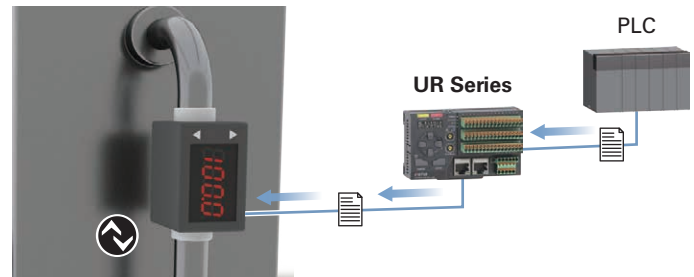

# Easy setup

Parameter settings for IO-Link pressure and flow sensors can be set from a host on the network. This **reduces the possibility of sensor setting errors or unintentional setting omissions**. The parameters once set can be backed up to the UR Series IO-Link master. If the sensor is replaced with one of the same model, the setting information can be restored to avoid accidentally different information than before.

At initial parameter set

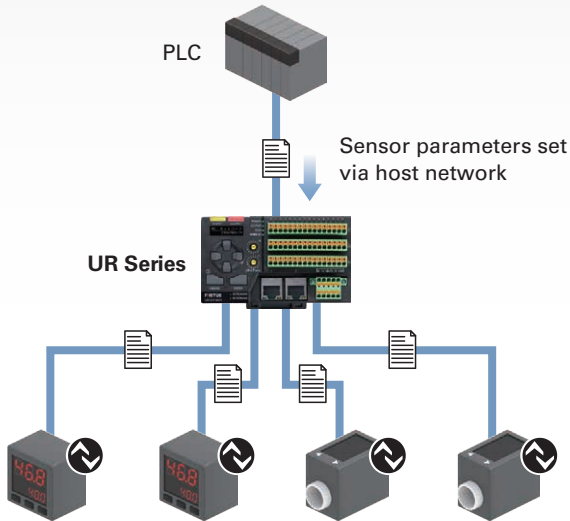

At maintenance replacement

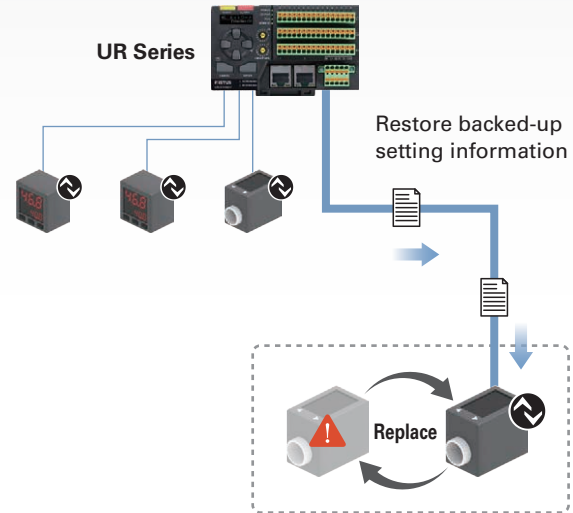



# Miswire / Wire Break Detection

Any point that differs from the preconfigured connection information will be detected as a miswire. Even if power to an IO-Link device (sensor) is cut off due to a wire break, the determination signal of the sensor is maintained without interruption, and the wire break can be detected.

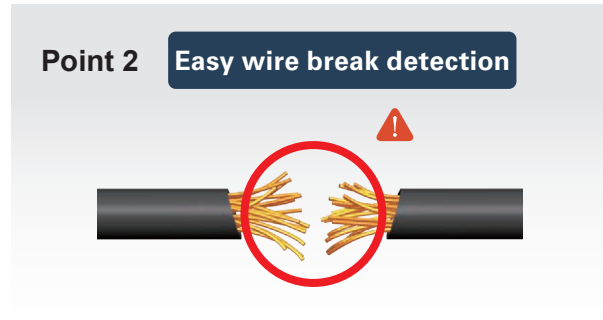
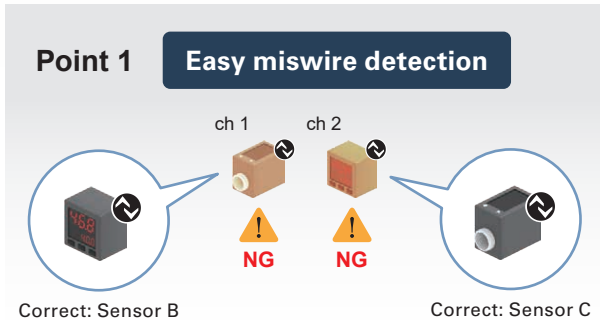
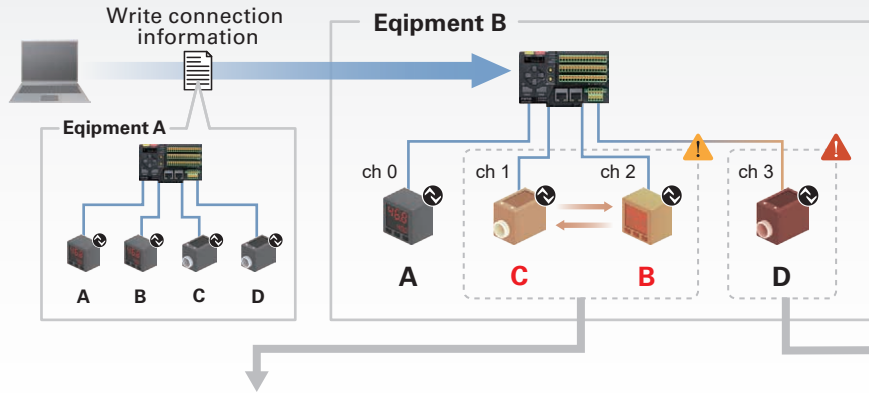

**IO-Link  
Master  
Features**

# Multi-point / Distributed I/O Control

In addition to IO-Link type devices, sink (NPN) and source (PNP) input/output devices can be connected to the IO-Link master, enabling effective use of remaining channels other than IO-Link type devices connection.

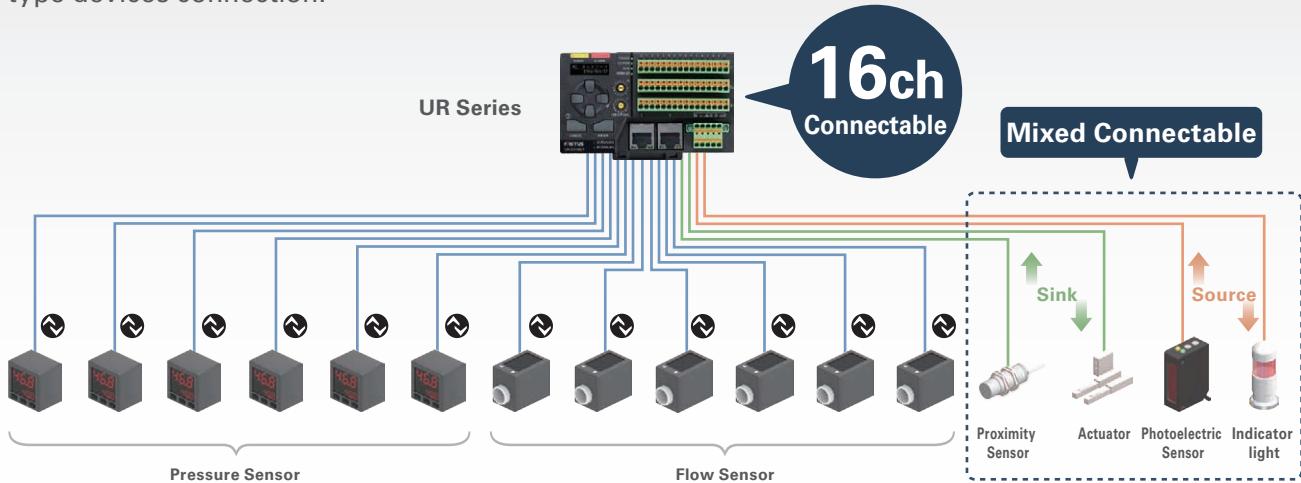

● Specifications are subject to change without prior notice. Thank you for your understanding.

**OPTEX  
FA** OPTEX FA CO., LTD.

91 Chudoji-Awata-cho Shimogyo-ku Kyoto 600-8815 JAPAN  
TEL. +81-(0)75-325-1314 FAX. +81-(0)75-325-2936  
www.optex-fa.com

