

10

Small object detection

Related products

Fiber amplifier

D3RF
 P.110

Fiber amplifier

BRF
 P.130



Small object detection with spot lens and fine core



- A small spot focus lens with adjustable spot size is available
- Suitable for handling small objects with a $\varnothing 0.125$ mm fine core (NF-TP01, NF-DP01)

Stable detection of small objects with spot lens

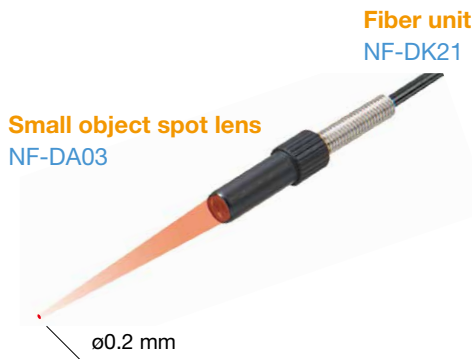
Fine spot lens [NF-DA03](#) and coaxial diffuse fiber unit [NF-DK21](#) enables $\varnothing 0.2$ mm spot.



Adjustable spot size

The [NF-DA06](#) comes with a small spot lens where sensing distance and spot size can be adjusted through the amount of fiber inserted. It is possible to change the spot size between $\varnothing 0.9$ and 1.9 mm with a distance of between 20 and 40 mm. The [NF-DA07](#), with its space-saving side view, is also available.

Adjustable spot size

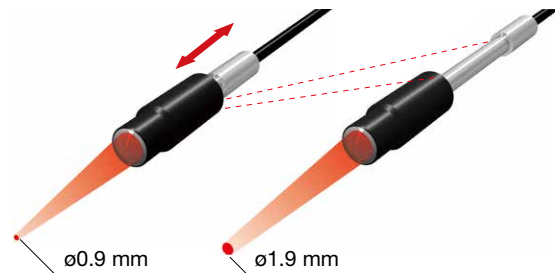

Detects small objects with a core diameter of $\varnothing 0.125$ mm Fine core

The [NF-TP01](#) through-beam type and the [NF-DP01](#) diffuse type use a $\varnothing 0.125$ mm fine core. Suitable for small object detection. The position of the fiber can be easily adjusted by attaching a sleeve.

NF-TP01 Fine core diameter: $\varnothing 0.125$ mm



NF-DP01 Fine core diameter: $\varnothing 0.125$ mm (4 cores)

Photoelectric Sensors

Photoelectric Sensors

Specialized Photoelectric Sensors

Laser Displacement Sensors

Fiber Units

Easy mounting

Thread type

Cylindrical type

Sleeve type

Flexible R4/R2

Flexible R1/R2

Retro-reflective

Small object detection

Screen/Array

Limited diffuse

Narrow view/wafer mapping

Heat resistant

Chemical resistant

Vacuum resistant

Liquid level/liquid leakage/water detection

Lens for through-beam type

Correct use

Small object detection lens (for diffuse type fibers)

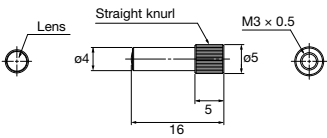
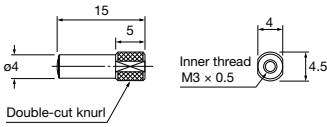
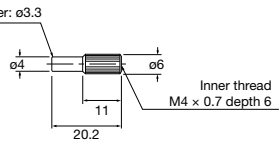
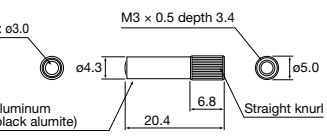
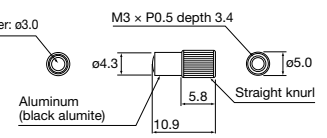
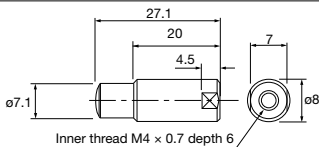
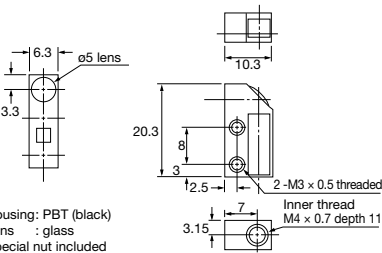
Type	Features/dimensions (unit: mm)	Spot size and supported fiber Parentheses indicate dia. of the smallest detectable object	Center sensing distance	Ambient temperature	Model
Small object spot lens	Housing: aluminum (black alumite) Lens : acrylic 	Approx. $\phi 0.2$ mm: NF-DK21 Approx. $\phi 0.4$ mm: NF-DT01 ($\phi 0.005$ mm metal wire)	7 mm	-20 to +60°C	NF-DA03 Small
	Housing: aluminum (black alumite) Lens : glass 	Approx. $\phi 0.3$ mm: NF-DK21 Approx. $\phi 0.5$ mm: NF-DT01 ($\phi 0.005$ mm metal wire)	7.5 mm	-40 to +70°C	NF-DA04
Small spot lens	Lens diameter: $\phi 3.3$ 	Approx. $\phi 0.5$ mm: NF-DM02 ($\phi 0.005$ mm metal wire)	6 mm	-40 to +70°C	NF-DA05
	Lens diameter: $\phi 3.0$ 	Approx. $\phi 0.2$ mm: NF-DK21 ($\phi 0.005$ mm metal wire) Approx. $\phi 0.4$ mm: NF-DT01 ($\phi 0.01$ mm metal wire)	6 mm	-40 to +70°C	NF-DA01
	Lens diameter: $\phi 3.0$ 	Approx. $\phi 1.2$ mm: NF-DK21 ($\phi 0.005$ mm metal wire) Approx. $\phi 1.4$ mm: NF-DT01 ($\phi 0.01$ mm metal wire)	15 mm	-40 to +70°C	NF-DA02
Spot size adjustable lens		Approx. $\phi 0.9$ to 1.9 mm: NF-DM02-G4 ($\phi 0.2$ mm metal wire)	Approx. 20 to 40 mm	-40 to +70°C	NF-DA06
Side view Lens with adjustable spot size		Approx. $\phi 0.8$ to 3.2 mm: NF-DM02-G4 ($\phi 0.1$ mm metal wire)	Approx. 9 to 17 mm	-40 to +70°C	NF-DA07

- Install with an ambient humidity between 35 and 85%. In the case of 85% RH, the ambient temperature should be between 0 and 40°C.
- The values for the smallest detectable object are typical values when set for the best to detect small objects on the fiber amplifier side.

Small object detection fiber units (through-beam type)

Type	Features/dimensions (mm)	Sensing distance Parentheses indicate dia. of the smallest detectable object Unit: mm			Ambient temperature	Bending radius (mm)	Model
		D3RF	D2RF	BRF			
Through-beam type	<p>Flexible</p> <p>Detecting part detail ø0.265 x 1</p>	<p>7-EL 54 6-UL 50 5-PL 44 4-LG 38 3-ST 25 2-FS 15 1-HS 5</p> <p>(ø0.02 metal wire)</p>	<p>Long 30 Std 18 Fast 8</p> <p>(ø0.02 metal wire)</p>	<p>10</p> <p>(ø0.02 metal wire)</p>	-40 to +60°C	R4	NF-TR04
	<p>Flexible, Free cut</p>	<p>7-EL 850 6-UL 550 5-PL 450 4-LG 400</p> <p>3-ST 275 2-FS 150 1-HS 50</p> <p>(ø0.1 metal wire)</p>	<p>Long 350 Std 200 Fast 90</p> <p>(ø0.1 metal wire)</p>	<p>110</p> <p>(ø0.1 metal wire)</p>	-40 to +70°C	R4	NF-TR03
	<p>Free cut</p>	<p>7-EL 900 6-UL 550 5-PL 400 4-LG 350</p> <p>3-ST 250 2-FS 140 1-HS 45</p> <p>(ø0.1 metal wire)</p>	<p>Long 350 Std 200 Fast 90</p> <p>(ø0.1 metal wire)</p>	<p>120</p> <p>(ø0.1 metal wire)</p>	-40 to +70°C	R15	NF-TM03
	<p>ø0.5 sleeve: 5 mm long, Free cut</p>	<p>7-EL 170 6-UL 110 5-PL 80 4-LG 70</p> <p>3-ST 50 2-FS 25 1-HS 8</p> <p>(ø0.1 metal wire)</p>	<p>Long 80 Std 40 Fast 20</p> <p>(ø0.1 metal wire)</p>	<p>30</p> <p>(ø0.1 metal wire)</p>	-40 to +70°C	R15	NF-TT01
<p>ø0.25 fine sleeve: 5 mm long</p> <p>Detecting part detail ø0.125 x 4</p>	<p>7-EL 27 6-UL 25 5-PL 21 4-LG 18 3-ST 12 2-FS 7 1-HS 2</p> <p>(ø0.02 metal wire)</p>	<p>Long 6 Std 3.5 Fast 2</p> <p>(ø0.02 metal wire)</p>	<p>1</p> <p>(ø0.02 metal wire)</p>	-40 to +70°C	R5	NF-TP01 Fine core	

- Install with an ambient humidity between 35 and 85%. In the case of 85% RH, the ambient temperature should be between 0 and 40°C.
- The values for the smallest detectable object are typical values when set for the best to detect small objects on the fiber amplifier side.

Small object detection fiber units (diffuse type)

Type	Features/dimensions (mm)	Sensing distance Parentheses indicate dia. of the smallest detectable object Unit: mm			Ambient temperature	Bending radius (mm)	Model
		D3RF	D2RF	BRF			
Diffuse type	<p>ø0.5 sleeve: 3 mm long</p> <p>Detecting part detail ø0.125 x 4</p>	<p>7-EL 28 6-UL 26 5-PL 23 4-LG 20 3-ST 13 2-FS 3 1-HS 1</p> <p>(ø0.02 metal wire)</p>	<p>Long 18 Std 5</p> <p>Unusable (ø0.02 metal wire)</p>	<p>3</p> <p>(ø0.02 metal wire)</p>	-40 to +60°C	R10	NF-DP01 Fine core

- The sensing distances for the diffuse type fiber units are values on 500 x 500 mm white paper.
- Install with an ambient humidity between 35 and 85%. In the case of 85% RH, the ambient temperature should be between 0 and 40°C.
- The values for the smallest detectable object are typical values when set for the best to detect small objects on the fiber amplifier side.

Correct use



Do not use this product as a detection device for protecting the human body.

Mounting

■ Mounting fibers with positioning bosses

<NF-DC08>

- Use an M2 countersunk screw (not included with this product). The positioning boss insertion holes on the bottom surface need to be $\phi 1.7$ mm and at least 0.8 mm deep.

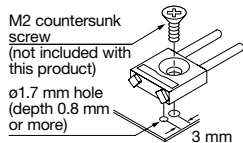

<NF-TE01/NF-DE01 (Flat ON type)>

If cutting a tap into the mounting surface

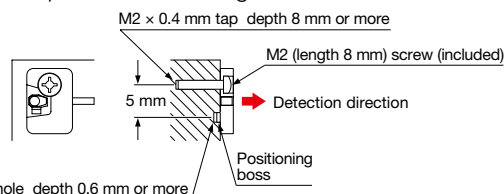

If using the included screw/nut

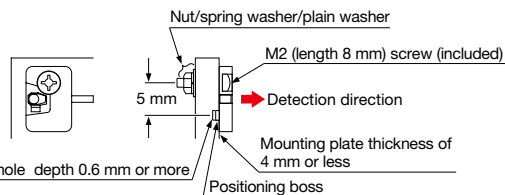

- (Note 1): The above diagram shows NF-TE01. The same mounting method is used for NF-DE01.
 (Note 2): Through-beam type fibers have the same shape. When mounting, pay attention to the positions of the mounting screw hole and positioning boss hole.

<NF-TE02/NF-DE02 (Head ON type)>

If cutting a tap into the mounting surface

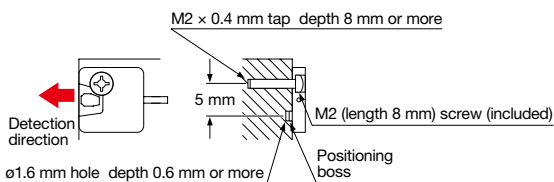

If using the included screw/nut

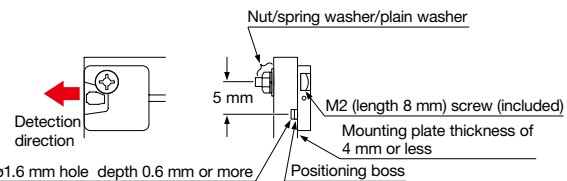

- (Note 1): The above diagram shows NF-TE02. The same mounting method is used for NF-DE02.
 (Note 2): Through-beam type fibers have the same shape. When mounting, pay attention to the positions of the mounting screw hole and positioning boss hole.

<NF-TE03/NF-DE03 (Flat ON type)>

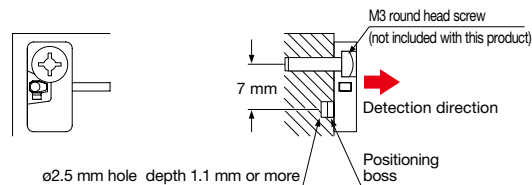

- (Note 1): The above diagram shows NF-TE03. The same mounting method is used for NF-DE03.
 (Note 2): Through-beam type fibers have the same shape. When mounting, pay attention to the positions of the mounting screw hole and positioning boss hole.

<NF-TE04/NF-DE04 (Head ON type)>

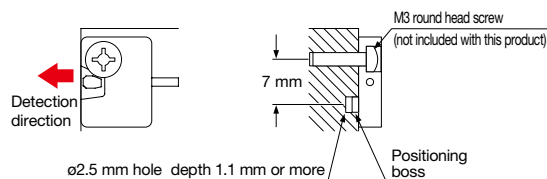

- (Note 1): The above diagram shows NF-TE04. The same mounting method is used for NF-DE04.
 (Note 2): Through-beam type fibers have the same shape. When mounting, pay attention to the positions of the mounting screw hole and positioning boss hole.

■ Mounting NF-DR09/-RR01

<If not using the included mounting bracket>

- Using a set screw (cup point of M3 or smaller), mount within 15 mm of head portion bracket edge.

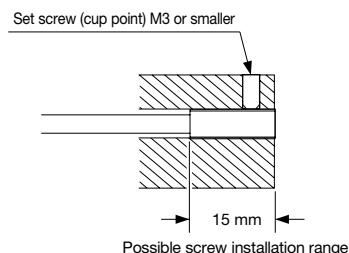

<If using the included mounting bracket>

- The head portion can be secured even without use of a set screw.
- If using a set screw, secure using a set screw with an M3 cup point.

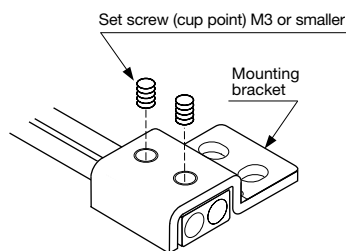

■ Mounting through-beam type screen fibers (NF-TZ07/-TZ08/-TZ09/-TZ10)

- Please be aware that because the aperture angle of this product is extremely narrow, light may not be taken in depending on installation conditions.
- When installing, determine a reference surface as shown in the diagram below while paying sufficient attention in regards to light axis shifting and slanting. Install so that emitting/receiving fibers are parallel.

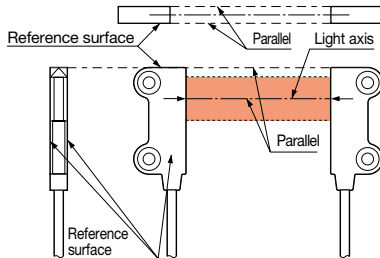

■ Mounting NF-RB02

- Because the aperture angle of this product is extremely narrow, light may not be taken in depending on installation conditions.
- As shown in the diagram below, install so that the centers of the fiber head and reflector are aligned. Pay attention for light axis shifting and slanting.

<Side ON type/NF-RB02>

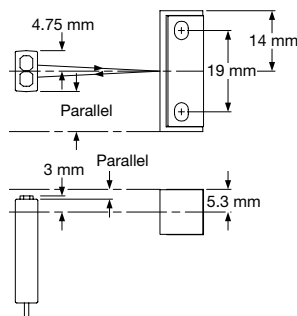

<Notes regarding NF-RB02>

- If detecting items such as transparent objects, detection may be unstable if the objects are within range of 0 to 20 mm from the window.

If mounting using the included fiber mounting bracket

- If using the fiber mounting bracket to mount a Side ON type fiber, mount so that there is no interference with the detecting part.

If mounting using the included fiber mounting bracket

- The fiber mounting bracket can be used to secure the fiber without use of an M3 set screw.

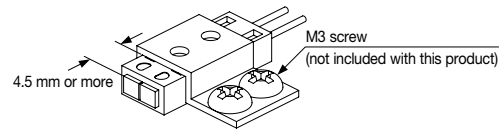

If mounting using an M3 set screw (cup point)

- Secure with an M3 set screw within the mounting range shown in the diagram below.

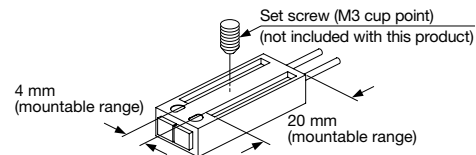

■ Mounting vacuum resistant fibers (NF-TN01/-DN01)

<Structure of vacuum resistant fibers>

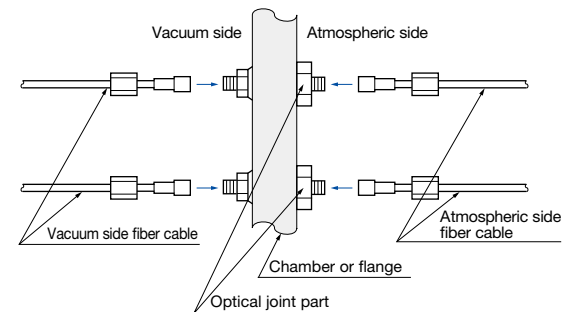

Leakage amount: 1.33×10^{-10} Pa·m³/s [He] or less

<Mounting>

1. Drill two holes into the vacuum chamber wall (chamber or flange).

(Note 1): Make the holes $\phi 5.5$ to $\phi 6.0$ mm.

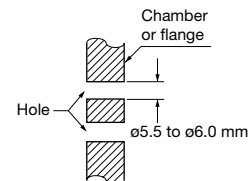

2. Mount the optical joint part to the vacuum chamber wall. When mounting to the vacuum chamber wall, the O-ring included with this product must be attached and the side to which it is attached must be the atmospheric side.

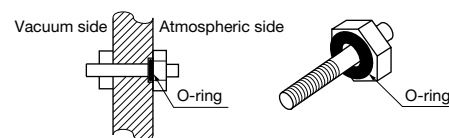

Correct use

- Mount the atmospheric side fiber cable bracket to the atmospheric side of the optical joint part.

(Note 1): Tighten the nut securely.

If the nut is loose, there may be a gap, causing the sensing distance to drop.

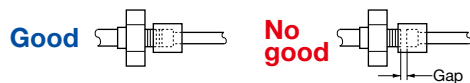

- Mount the vacuum side fiber nut to the vacuum side of the optical joint part.

(Note 1): Tighten the nut securely.

If the nut is loose, there may be a gap, causing the sensing distance to drop.

- Secure the tip of the vacuum side fiber.

<For NF-DN01>

If using a mounting bracket

- Tighten using a set screw (cup point of M3 or smaller).
- By mounting the mounting bracket to the housing, it is possible to automatically secure the head without using a set screw.

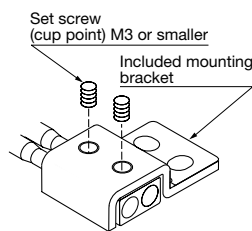

If not using a mounting bracket

- As shown in the diagram to the right, using a set screw (cup point of M3 or smaller), secure within 15 mm of head portion edge.

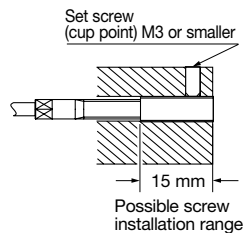

Mounting heat resistant joint fibers (NF-TH12/-TH13/-TH14/-TH15/-TH16)

<Connecting heat resistant joint fibers to Ordinary temperature side fibers>

- Use the following procedure to connect normal temperature side fibers.

Procedure

- Attach the plastic nut included with the heat resistant joint fiber and spring washer as far as possible on the fiber tip of the normal temperature side fiber.

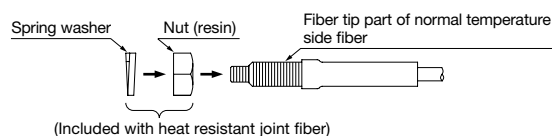

- Mount the heat resistant joint fiber and normal temperature side fiber using a lock nut.

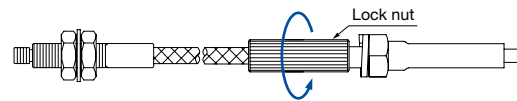

(Note 1): Do not secure the lock nut using the plastic nut and spring washer from Procedure 1.

- To prevent the lock nut from becoming loose, secure using the plastic nut used for mounting in Procedure 1.

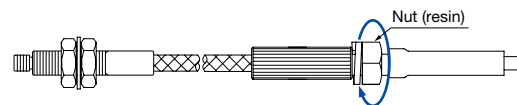

<If mounting connecting parts to the mounting plate>

- If securing parts that connect the heat resistant joint fiber and normal temperature side fiber to the mounting plate using the included metal nuts, use the procedure below.
- The mounting plate thickness needs to be 1 mm or thinner.

Procedure

- Remove the protective tube from the normal temperature side fiber, attach the included metal nut from the tip of the fiber and move it to the fiber part.
- Insert the tip of the fiber into the mounting plate.
- Connect the heat resistant joint fiber to the normal temperature side fiber using the same procedure from <Connecting heat resistant joint fibers to normal temperature side fibers>
- Tighten the metal nut mounted in Procedure 1 to the mounting plate.

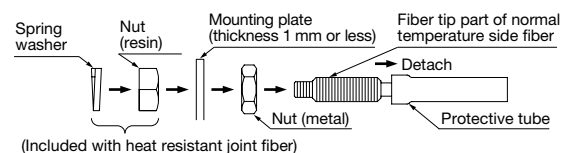

<Operating Temperature>

- In order to protect normal temperature side fibers and amplifiers, keep the heat resistant joint fiber at least 100 mm from the boundary of the normal temperature side as shown in the diagram below.

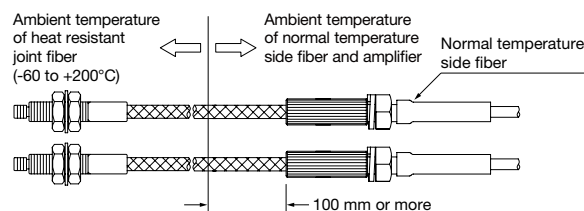

■ Mounting narrow view/wafer mapping fibers (NF-TG01/-TG02/-TG03/-TG04)

- Please be aware that because the aperture angle of this product is extremely narrow, light may not be taken in depending on installation conditions.

<Through-beam type>

- When installing, determine a reference surface as shown in the diagram below while paying sufficient attention in regards to light axis shifting and slanting. Install so that emitting/receiving fibers are parallel.

NF-TG01

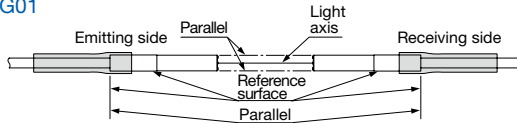

NF-TG02/-TG03/-TG04

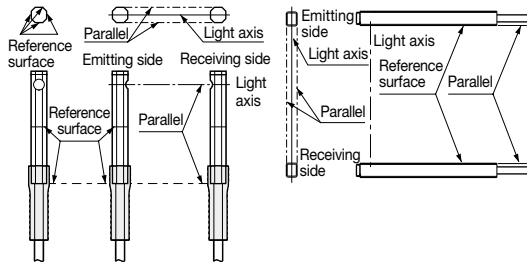

<Reflective type>

- Use the included 1.6 mm M1.4 screws to mount the fiber head and reflector to the mounting plate as shown in the diagram to the right. The mounting plate needs to have a thickness of 0.9 mm or thinner.
- Use a thread lock compound to tighten screws when mounting them in places with vibrations or shocks.
- Install the parts so that the mounting holes for the fiber head and reflector are parallel to one another and so that parts A, B and C are each parallel as shown in the diagrams below. Pay sufficient attention for light axis shifting and slanting.

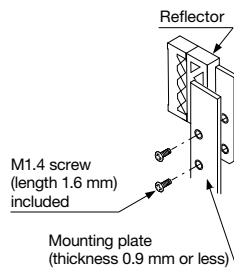
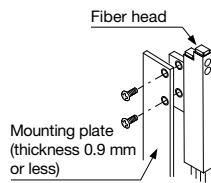

<Overhead view>

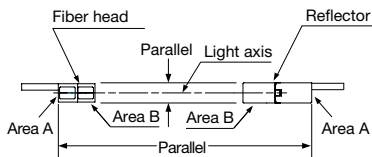

<Side view>

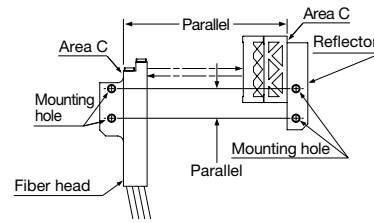

■ Mounting liquid leakage detection fibers (NF-DW02)

- If using an SUS mounting bracket, thread a welded M4 stud bolt through the mounting hole on the mounting bracket and attach an M4 nut (not included with this product).

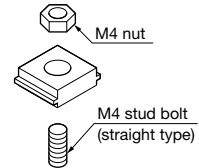

- If using a PVC mounting bracket, glue it to the mounting surface so that the side with "TOP" is facing up. Also, weld it within the welding area as shown in the diagram to the right.

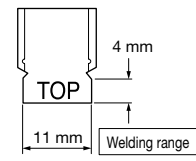

- Slide the convex portion of the mounting bracket attached to the steel case into the concave portion on the fiber until a "click" is heard.

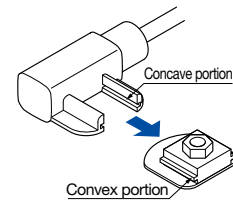

■ Mounting pipe-mounted liquid level detection fibers (NF-TF01)

- Use the included zip ties and anti-slip tubes for mounting as shown in the diagram below. Also, use two zip ties on the upper and lower part to attach it securely, and cut off the any part of the zip ties that stick out.

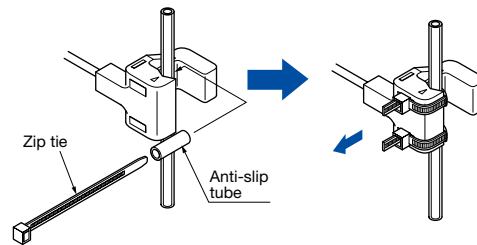

- When additional zip ties are necessary, please use zip ties with a thickness 2.5 mm or smaller as shown by (A) in the diagram below.

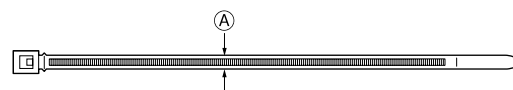

Correct use

■ Mounting pipe-mounted liquid level detection fibers (NF-DF04/-DF05)

- Use the included zip ties and anti-slip tubes for mounting as shown in the diagram below. When mounting the fiber, make sure that the mounting position adjusting lever is in the closed position as shown in the diagram below. Also, use two zip ties on the upper and lower part to attach it securely, and cut off the any part of the zip ties that stick out.

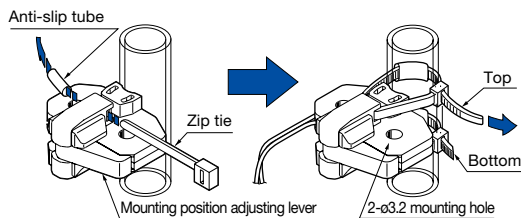

- When additional zip ties are necessary, please use zip ties with a thickness 2.5 mm or smaller as shown by ① in the diagram below.

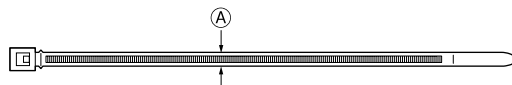

- M3 screws, plain washers and spring washers must be used when using the mounting holes. (M3 screws, plain washers and spring washers are not included with this product.)

<Adjusting the positions of pipe-mounted liquid level detection fibers>

- The attachment position can be easily readjusted when using zip ties to mount this product.

■ Adjustment method

- Pull the mounting position adjusting lever open in the direction of the arrow.
- Push the moveable part in the direction of the arrow to loosen the zip tie, and readjust the mounting position.
- Close the mounting position adjusting lever in the direction of the arrow to return it to its original position.

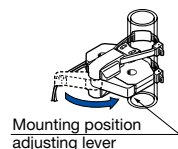
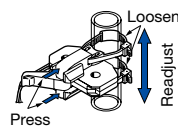
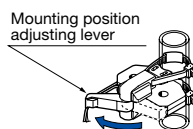

(Note 1): Sensitivity settings must be reconfigured after readjusting the mounting position.

(Note 2): The positioning lever is for readjusting the mounting position on this device, not for tightening the zip ties. Tightening the zip ties while the mounting position adjusting lever is open and then closing the mounting position adjusting lever will damage the fibers.

■ Mounting chemical resistant angled-head fibers (NF-TY05)

- Use M3 screws and tighten them to a torques of 0.3 N·m or less.

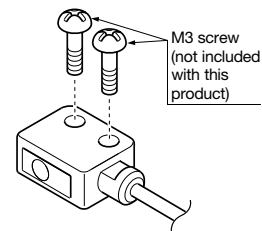

Notes regarding usage of heat resistant fibers

- In order to protect amplifiers, keep the heat resistant fiber part at least 150 mm from the boundary of the normal temperature side as shown in the diagram below.

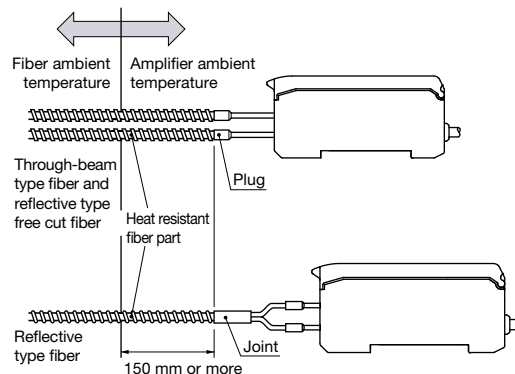

- Do not directly expose amplifiers to radiation heat or hot air.
- The tip bracket of the heat resistant fiber (up to 350°C) and stainless steel sheath may change color when used at high temperatures, but this does not affect their detection capability.

Notes about slit masks included with NF-TZ07/-TZ08/-TZ09/-TZ10

- There are two types of slit masks included with these products (one type for NF-TZ07/-TZ08). These slit masks can be used when detecting small objects or for preventing light saturation when using the fibers at close range. However, applying slit masks shortens the sensing distance. Because the slit masks are of an adhesive type, when applying them to the fibers, align the slit projection with the top of the fiber as shown in the diagram on the upper right.

Photoelectric Sensors

Specialized Photoelectric Sensors

Laser Displacement Sensors

Fiber Units

Easy mounting

Thread type

Cylindrical type

Sleeve type

Flexible R4/R2

Flexible R1/R2

Retro-reflective

Small object detection

Screen/Array

Limited diffuse

Narrow view/wafer mapping

Heat resistant

Chemical resistant

Vacuum resistant

Liquid level/liquid leakage/water detection

Lens for through-beam type

Correct use

Included slit masks

How to apply

<NF-TZ09/-TZ10>

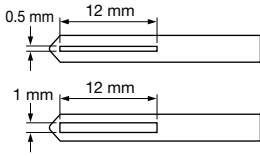

<NF-TZ07/-TZ08>

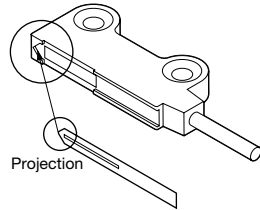
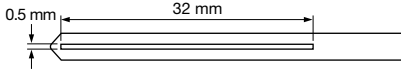

For NF-TY01(-□)/-TY02(-□)/-TY03-TF3/-TY04/-TY05(-□)/-DY01

- Avoid use with the chemicals listed below. Chemicals that may erode PFA including fused alkali metals (sodium, potassium, lithium, etc.), fluorine gas (F₂), ClF₃, OF₂ (including gaseous form), etc. Also, chemicals with high permeability including high temperature hydrofluoric acid, nitric acid, chlorine, etc.

Notes regarding usage of NF-TY04/-DY01 (heat resistant type)

- In order to protect amplifiers, keep the heat resistant fiber part at least 150 mm from the boundary of the normal temperature side as shown in the diagram on the right.
- Do not directly expose amplifiers to radiation heat or hot air.

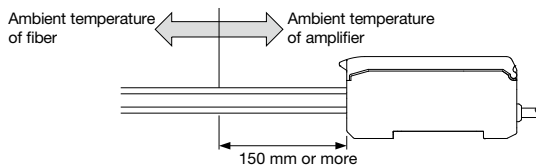

Notes regarding usage of NF-DA06

- Spot size and sensing distance can be adjusted depending on the fiber insertion amount. Be aware that if inserted too deeply, the fiber tip may become separated from the lens.

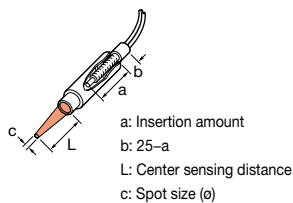
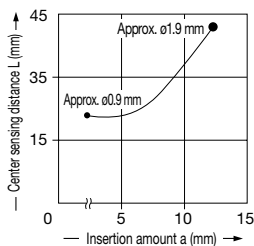

- After setting the fiber and NF-DA06, secure using the nut included with the fiber to prevent moving caused by vibrations, etc.

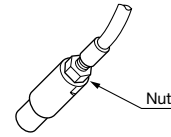

- If securing NF-DA06 using a set screw, use an M3 set screw (cup point).

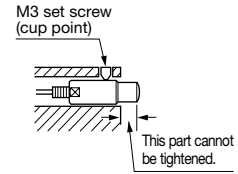

Notes regarding usage of NF-DA01/-DA02/-DA03/-DA04/-DA05

- If inserting fibers into NF-DA01/-DA02/-DA03/-DA04/-DA05, inserting until the fiber comes to a stop.

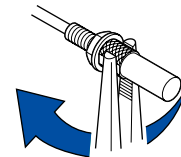

Notes regarding usage of NF-DA07

- Spot size and sensing distance can be adjusted depending on the fiber insertion amount.

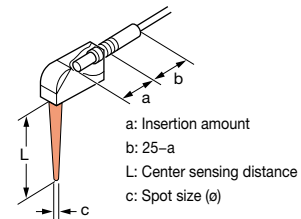
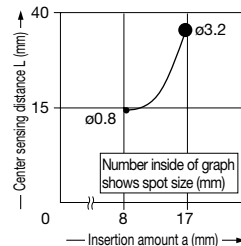

- After setting the fiber and NF-DA07, secure using the special nut included with NF-DA07 to prevent moving caused by vibrations, etc.

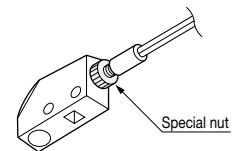

Correct use

Notes regarding liquid leakage/liquid level detection/chemical resistant fibers

- Clean **NF-DW02** by wiping away all liquids that have adhered to the head and mounting bracket using a soft cloth. Also pay sufficient attention to any condensation that has formed on the detecting part.
- If the tips of the **NF-DW02/-TF01** fibers are too short, be aware that the correct amounts of light may not be taken in, resulting in unstable detection.
- When installing **NF-DW02**, be sure to use the special mounting bracket as a countermeasure to human error (improper installation, etc.) Failure to use the special bracket may result in unstable detection. However, if using a PVC mounting bracket on the black matte part of the housing, sensing of human error (improper installation) may not be possible. Please confirm before using.
- When cutting the protective tubes, take care not to damage the fiber sheath.
- Perform sensitivity settings for the **NF-DW02** only after any liquids have been removed, the head has been mounted to the special mounting bracket, and the fiber has been attached to the amplifier. After performing the sensitivity adjustment, changing the fiber connection or installation will result in changes in the light detection volume, causing unstable detection. Changing fiber connections or installation during cleaning, etc., will have the same results. In such cases, perform amplifier sensitivity adjustments again.
- Amounts of light may decrease during extended periods of usage under conditions with high heat or humidity.
- Be aware that instability may occur in which a long period is necessary before detection stability can be regained if liquids incompatible with the materials of which the **NF-DW02** head part is made (PFA) cause air bubbles to flood the detecting part. Always confirm the liquid to be detected before use.
- When cleaning the **NF-DW02** confirm that the mounting bracket shows no scratching, contamination, or deformities.
- Water droplets adhered to the window will influence detection performance. Avoid use in areas where direct contact with water could be made. Also pay sufficient attention to any condensation that has formed on the pipe exterior.

- Be aware that the **NF-TF01/-DF04/-DF05** may not be able to detect some low-transparency liquids and highly-viscous liquids with stability.
- Incomplete pipe mounting of **NF-TF01/-DF04/-DF05** may have a severe influence on detection performance. Use the included anti-slip tubes and install the detecting part to the pipe so it does not move.
- For the **NF-TF01** to detect in a stable manner, amplifier sensitivity adjustments must be performed when there is no liquid in the pipe and after the fiber has been installed. Also, sensitivity must be reconfigured if the fiber installation condition on the pipe is altered, or if its routing is changed.
- The **NF-DF04/-DF05** cannot properly detect through opaque pipes.
- Attach the detecting part of the **NF-DF04/-DF05** so it is secured to the pipe. Failure to do so will result in malfunction.
- Because the **NF-DF04/-DF05** does not have a water resistant or chemical resistant structure, avoid areas where water or chemicals could come in contact.
- Because adherence of water droplets on the window of the **NF-DF04/-DF05** will affect detection, pay sufficient attention to any condensation that has formed on the pipe exterior. Also be aware that water droplets formed on the inside of pipes, as well as air bubbles adhered on the inside will affect detection.

General notes

Regarding fiber units

1. Do not hit or damage the detection head surface.

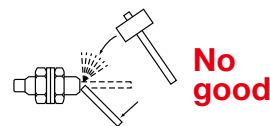

2. Do not bend or apply excessive force to the fiber.

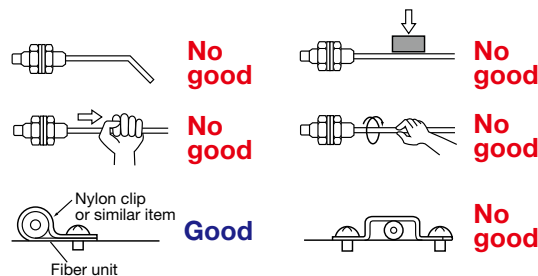

3. Do not apply excessive torque to the sensor head or use tools that do not match the nuts.

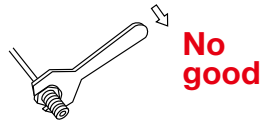

4. Do not twist in the gaps between the fiber cable and fiber adapter.

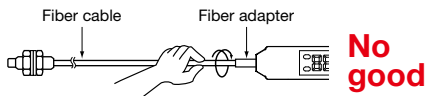

5. Depending on the bore shape of the sensor head, mount as shown in the diagrams below.

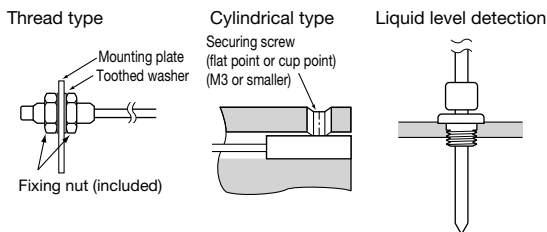

6. In the case of fibers that can be free cut, cut the tip with special fiber cutters before mounting to the fiber amplifier.
7. The fiber unit bending radius should be greater than the allowable bending radius. Excessive bending will shorten the sensing distance.
8. Allow for some wire to remain straight near the insertion and tip parts of the fiber unit.

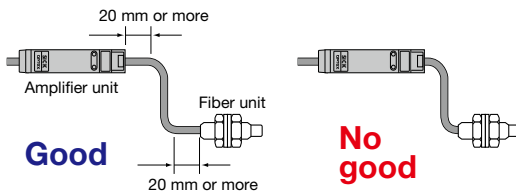

9. Because sensing distance may decrease by as much as 20% depending on the conditions of cut surface of the fiber or connection conditions with the amplifier, we recommend using with sensing distance set at 80% or below.
10. In areas subject to frequent vibration, secure so that the fiber unit itself will not vibrate. Especially work to limit vibrations from reaching connection points between the fiber and amplifier.

11. Use the method shown below to soften fiber head vibrations.

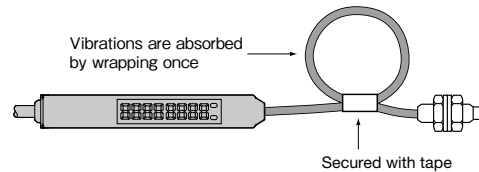

12. Do not use fiber units not protected with fluoroplastic in environments where organic solvents are used.

13. Do not bend the sleeve tip or base.

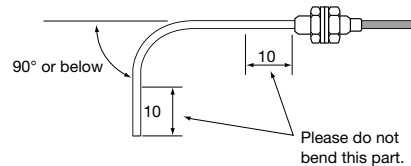

■ Regarding fiber cutters

Cutting procedure

1. Adjust the length in the direction of the arrow, turn the stopper and lock the fiber in place.

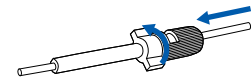

2. Insert the fiber into the fiber cutter and cut it.

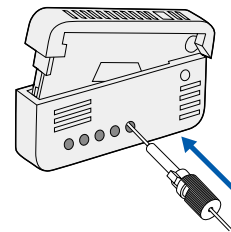

3. The procedure is complete. (Correctly cut fiber)

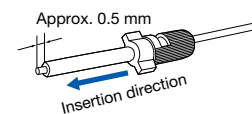
Photoelectric
SensorsSpecialized
Photoelectric
SensorsLaser
Displacement
Sensors

Fiber Units

Easy mounting

Thread type

Cylindrical type

Sleeve type

Flexible R4/R2

Flexible R1/R2

Retro-reflective

Small object
detection

Screen/Array

Limited diffuse

Narrow view/
wafer mapping

Heat resistant

Chemical
resistantVacuum
resistantLiquid level/liquid leakage/
water detectionLens for
through-beam type

Correct use