

FM Series

DIN W72×H72mm Up·Down Measure Counter

■ Features

- Parameter Setting
 - : Input/Output operation mode, Max. counting speed, Decimal point position, OUT1/2 time (0.01 to 99.99 sec), Selectable voltage input (PNP) method or no-voltage input (NPN) method, Selectable Multiply or Divide mode function.
- Memory protection for 10 years (using non-voltage semiconductor)
- Power supply: 100-240VAC 50/60Hz
- Built-in Microprocessor



⚠ Please read "Safety Considerations" in the instruction manual before using.



■ Ordering Information

FM	4	M	—	1P	4
Size	Display digit	Function	Output	Power supply	
FM	4	M	1P	4	100-240VAC 50/60Hz
			2P		1-stage setting
			I		2-stage setting
					Indicator
					Measure function
					9999 (4-digit)
					999999 (6-digit)
					DIN W72×H72mm



■ Specifications

Model	1-stage setting		FM4M-1P4		FM6M-1P4	
	2-stage setting		FM4M-2P4		FM6M-2P4	
Indicator		FM4M-I4		FM6M-I4		
Display digit		4-digit		6-digit		
Character size (W×H)		6×10mm		4×8mm		
Power supply		100-240VAC~ 50/60Hz				
Permissible voltage range		90 to 110% of rated voltage				
Power consumption		●1-stage: max. 4.6VA		●2-stage: max. 5.8VA		
Max. counting speed of CP1/CP2		●Indicator: max. 3.8VA				
Max. counting speed of CP1/CP2		Selectable 1cps / 30cps / 300cps / 2kcps / 5kcps				
Return time		Max. 500ms				
Min. signal width		RESET: approx. 20ms				
Input method		Selectable voltage input (PNP) method or no-voltage input (NPN) method [Voltage input (PNP) method]-input impedance: max. 10.8kΩ, [H]: 5-30VDC≐, [L]: 0-2VDC [No-voltage input (NPN) method]-short-circuit impedance: max. 470Ω, short-circuit residual voltage: max. 1VDC, open-circuit impedance: min. 100kΩ				
One-shot output time		0.01 to 99.99 sec				
Control output	Contact	Type	●1-stage: Instantaneous SPDT (1c)			
		Capacity	●2-stage: Instantaneous OUT1-SPST (1a), Instantaneous OUT2-SPST (1a)			
Solid state	Type	250VAC~ 3A, 30VDC≐3A resistive load				
	Capacity	●1-stage: 1 NPN open collector ●2-stage: OUT1-1 NPN open collector, OUT2-1 NPN open collector				
Relay life cycle	Mechanical	●Load voltage: max. 30VDC≐ ●Load current: max. 100mA ●Residual voltage: max 1VDC≐				
		Electrical				
Insulation resistance		Min. 5,000,000 operations				
External power supply		Min. 100,000 operations (250VAC 3A resistive load)				
Memory retention		Over 100MΩ (at 500VDC megger)				
Dielectric strength		Max. 12VDC≐±10% 50mA				
Noise immunity		Approx. 10 years (non-volatile memory)				
		2,000VAC 50/60Hz for 1 min (between all terminals and case)				
		±2kV the square wave noise (pulse width 1μs) by noise simulator				



Up-Down Measure Counter

Specifications

Model	1-stage setting	FM4M-1P4	FM6M-1P4
	2-stage setting	FM4M-2P4	FM6M-2P4
	Indicator	FM4M-I4	FM6M-I4
Vibration	Mechanical	0.75mm amplitude at frequency 10 to 55Hz (for 1 min) in each X, Y, Z direction for 1 hour	
	Malfunaction	0.5mm amplitude at frequency 10 to 55Hz (for 1 min) in each X, Y, Z direction for 10 min	
Shock	Mechanical	300m/s ² (approx. 30G) in each X, Y, Z direction for 3 times	
	Malfunaction	100m/s ² (approx. 10G) in each X, Y, Z direction for 3 times	
Environment	Ambient temp.	-10 to 55°C, storage: -25 to 65°C	
	Ambient humi.	35 to 85%RH, storage: 35 to 85%RH	
Protection structure		IP20 (front part, IEC standard)	
Approval		 	
Weight ^{*1}	1-stage setting	Approx. 245g (approx. 180g)	
	2-stage setting	Approx. 265g (approx. 200g)	
	Indicator	Approx. 225g (approx. 160g)	

※1: The weight includes packaging. The weight in parenthesis is for unit only.

※Environment resistance is rated at no freezing or condensation.

Connections

FM□M-2P4

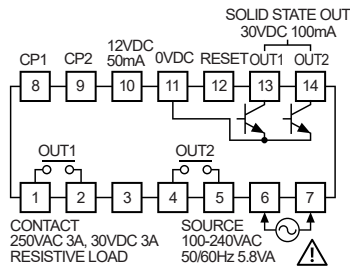

FM□M-1P4

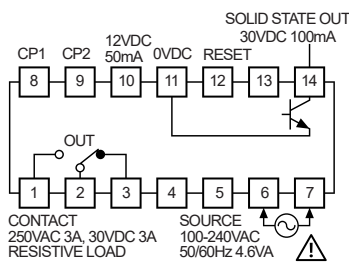

FM□M-I4

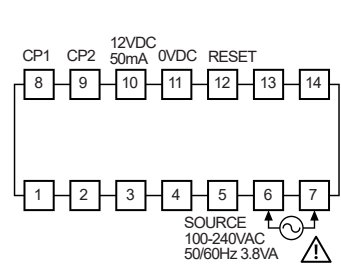

Dimensions

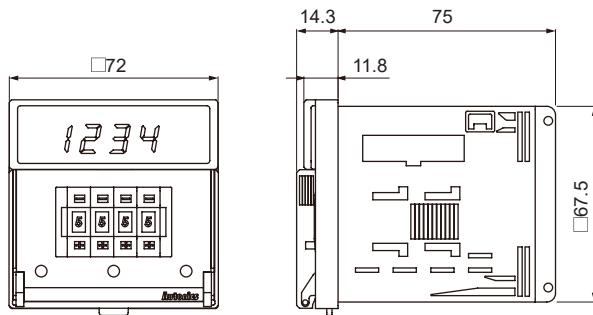

(unit: mm)

Bracket

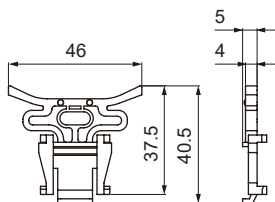

Panel cut-out

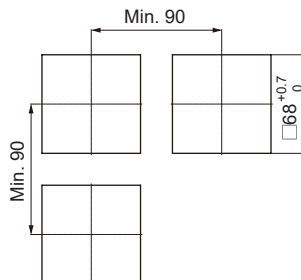

SENSORS

CONTROLLERS

MOTION DEVICES

SOFTWARE

(J) Temperature Controllers

(K) SSRs

(L) Power Controllers

(M) Counters

(N) Timers

(O) Digital Panel Meters

(P) Indicators

(Q) Converters

(R) Digital Display Units

(S) Sensor Controllers

(T) Switching Mode Power Supplies

(U) Recorders

(V) HMIs

(W) Panel PC

(X) Field Network Devices

FM Series

Input Connections

Voltage input (PNP)

Solid-state input (standard sensor: PNP output type sensor)

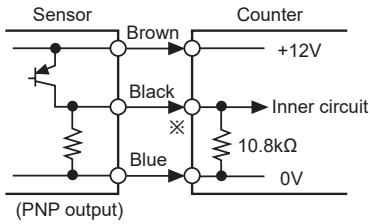

※CP1, CP2, RESET input part

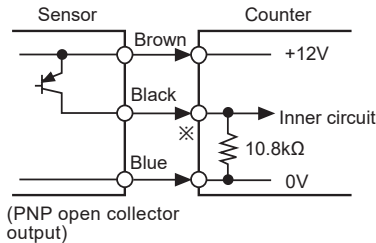

(PNP open collector output)

Contact input

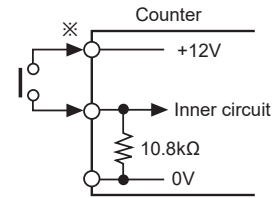

※Counting speed
: Set as 1 or 30cps

No-voltage input (NPN)

Solid-state input (standard sensor: NPN output type sensor)

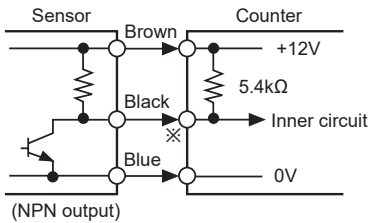

※CP1, CP2, RESET input part

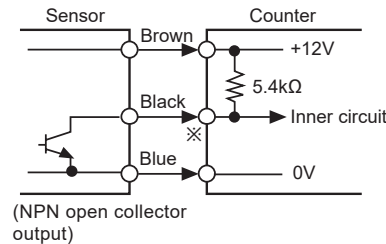

(NPN open collector output)

Contact input

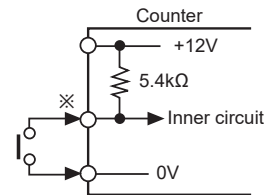

※Counting speed
: Set as 1 or 30cps

Input & Output Connections

When operation load by sensor power

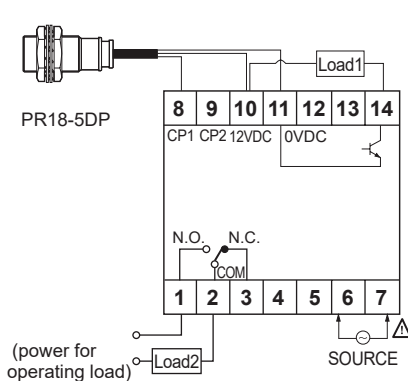

- The sum of operating current capacity of load 1 and sensor should not be over external power capacity (50mA).

When operating load by external power

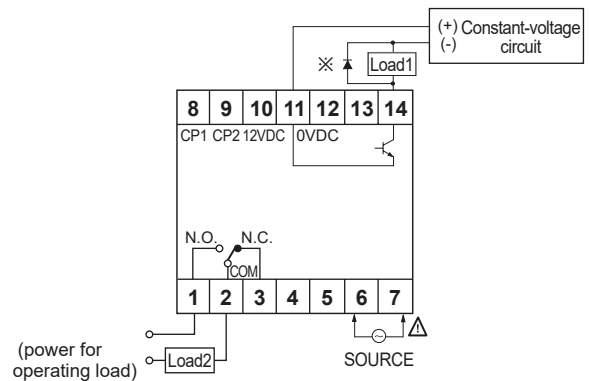

- The capacity of load 1 should not be over transistor switching capacity (max. 30VDC, 100mA)
- Do not supply the reverse polarity power.
- ※when using inductive load (relay, etc.), connector surge absorber at both ends of the load 1

Up-Down Measure Counter

Parameter Setting

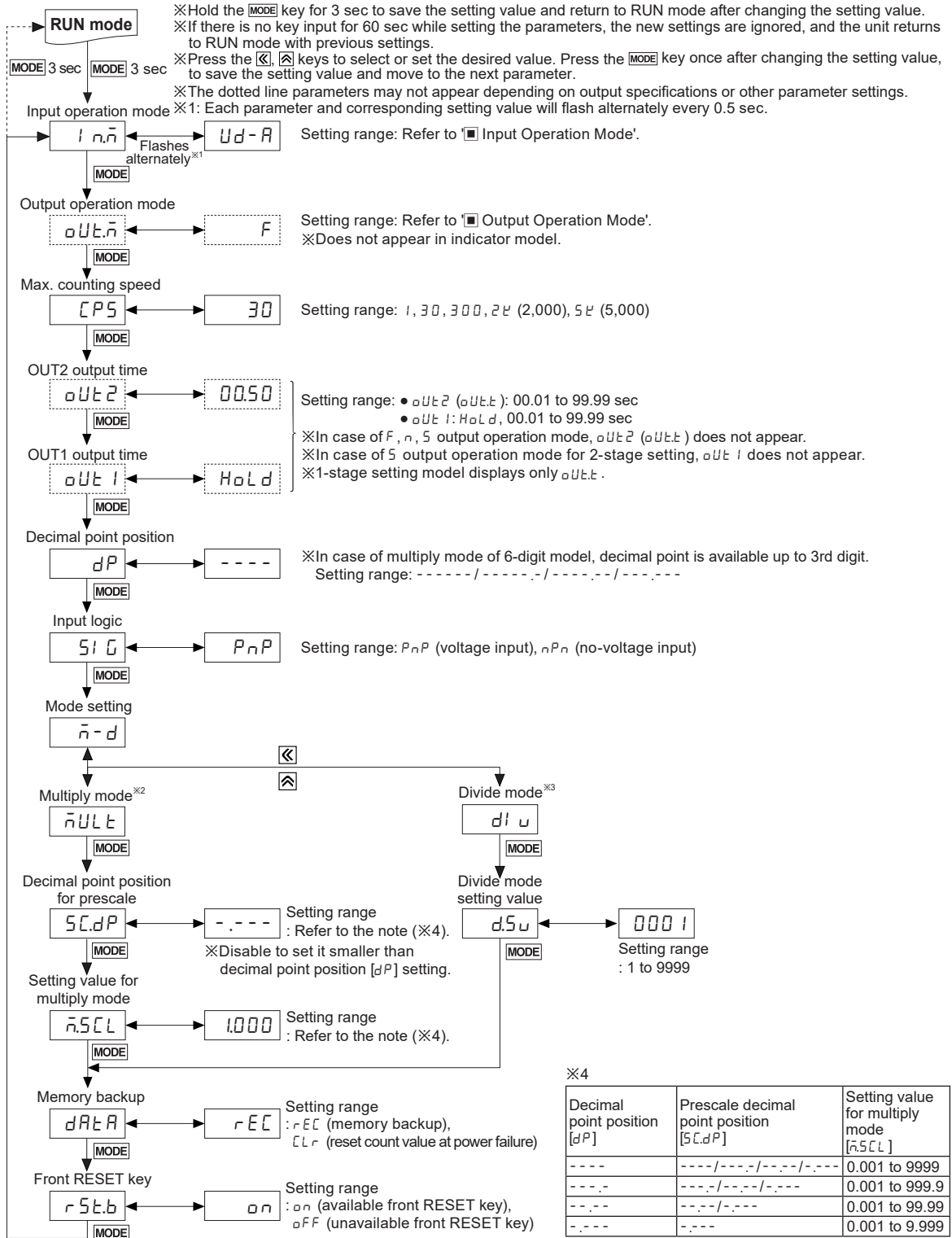

※2: Multiply mode [nULt]: Displayed by multiplying input signal and setting value.
 Input signal × Setting value = Display value (input signal: 1, setting value: 4, it displays 4(1×4))
 ※3: Divide mode [dlu]: Displays 1 when input signals are input as the setting value.
 Input signal / Setting value = Display value (input signal: 4, setting value: 4, it displays 1(4/4))

SENSORS
CONTROLLERS
MOTION DEVICES
SOFTWARE
(J) Temperature Controllers
(K) SSRs
(L) Power Controllers
(M) Counters
(N) Timers
(O) Digital Panel Meters
(P) Indicators
(Q) Converters
(R) Digital Display Units
(S) Sensor Controllers
(T) Switching Mode Power Supplies
(U) Recorders
(V) HMIs
(W) Panel PC
(X) Field Network Devices

FM Series

■ Measure Counter

Measure counter sets multiply or divide integer per 1 pulse input.

● Multi Mode

It multiplies the inner SW3 setting value at a count input signal and displays it.

Input signal (N) × Multi Mode preset value = Indication value

∴ $N \times 4 = 4, 8, 12 \dots$ (N=1, 2, 3 ..)

● Divide Mode

It displays as 1 when the count input signal is entered as preset value of inner SW3.

$\frac{\text{Input signal (N)}}{\text{Divide Mode preset value}} = \text{Indication value}$

∴ $\frac{N}{5} = 1, 2, 3 \dots$ (N=5, 10, 15 ..)

※Please be cautious the error can occur when down count is executed during up count.

■ Counting Operation for Indicator (FM□M-I4)

● Input mode: Up

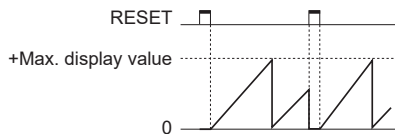

● Input mode: Down

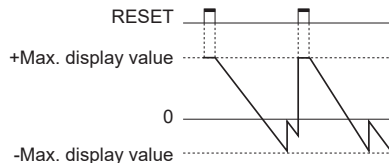

● Input mode: Up / Down-A, B, C

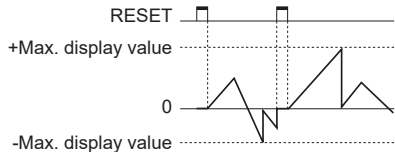

● Input mode: Up / Down-D, E, F

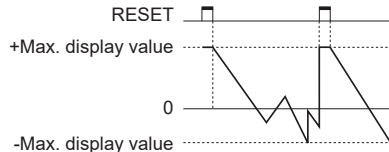

※- display is only for F, K, Q, S output operation mode and it cannot be set.

■ Factory Default

Parameter	Default	Parameter	Default	Parameter	Default	Parameter	Default
$i n \bar{n}$	<i>Ud-R</i>	$oUt2$	<i>00.50</i>	<i>St G</i>	<i>PnP</i>	$\bar{n}SC L$	<i>1000</i>
$oUt \bar{n}$	<i>F</i>	$oUt 1$	<i>Hold</i>	$\bar{n}-d$	$\bar{n}ULt$	<i>dRtR</i>	<i>rEC</i>
<i>CP5</i>	<i>30</i>	<i>dP</i>	<i>---</i>	<i>SCdP</i>	<i>---</i>	<i>r5t.b</i>	<i>on</i>

■ Error Display and Output Operation

Error Display	Error description	Troubleshooting
<i>Err0</i>	Setting value is 0.	Change the setting value anything but 0.

※When error occurs, the output turns OFF.

※When 1st setting value is set as 0 (zero), OUT1 maintains OFF.

When 2nd setting value is smaller than 1st setting value, 1st setting value is ignored and only OUT2 output operates.

※Indicator model does not have error display function.

Up-Down Measure Counter

Input Operation Mode

※CP: Clock Pulse

Input mode	Voltage input (PNP) method	No-voltage input (PNP) method
Up/Down-A command input [Ud - A]		
Up/Down-B individual input [Ud - b]		
Up/Down-C phase difference input [Ud - C]		
Up adding input [UP]		
Up/Down-D command input [Ud - d]		
Up/Down-D individual input [Ud - E]		
Up/Down-F phase difference input [Ud - F]		
Down subtracting input [dn]		

※A: over min. signal width, B: over than 1/2 of min. signal width. If the signal is smaller than these width, it may cause counting error (±1).

SENSORS
CONTROLLERS
MOTION DEVICES
SOFTWARE
(J) Temperature Controllers
(K) SSRs
(L) Power Controllers
(M) Counters
(N) Timers
(O) Digital Panel Meters
(P) Indicators
(Q) Converters
(R) Digital Display Units
(S) Sensor Controllers
(T) Switching Mode Power Supplies
(U) Recorders
(V) HMIs
(W) Panel PC
(X) Field Network Devices

FM Series

Output Operation Mode

		 One-shot output of OUT2 (0.01 to 99.99 sec)	 Self-holding output of OUT1 (0.01 to 99.99 sec)	 Self-holding output
Output mode	Input mode			Operation
	Up, Up/Down-A, B, C	Down, Up/Down-D, E, F		
F [F]	 RESET, 2nd setting, 1st setting, 0, OUT1, OUT2 (OUT)	 RESET, 2nd setting, 1st setting, 0, OUT1, OUT2 (OUT)	After count-up, counting display value increases or decreases until reset signal input is applied and self-holding output is maintained.	
N [N]	 RESET, 2nd setting, 1st setting, 0, OUT1, OUT2 (OUT)	 RESET, 2nd setting, 1st setting, 0, OUT1, OUT2 (OUT)	After count-up, counting display value and self-holding output are maintained until reset signal input is applied.	
C [C]	 RESET, 2nd setting, 1st setting, 0, OUT1, OUT2 (OUT)	 RESET, 2nd setting, 1st setting, 0, OUT1, OUT2 (OUT)	When count-up, counting display value is reset and it counts simultaneously. Self-holding output of OUT1 turns OFF after one-shot output time of OUT2. One-shot output time of OUT1 is regardless of OUT2 output.	
R [R]	 RESET, 2nd setting, 1st setting, 0, OUT1, OUT2 (OUT)	 RESET, 2nd setting, 1st setting, 0, OUT1, OUT2 (OUT)	After count-up, counting display value is reset after one-shot output time of OUT2 and it counts simultaneously. Self-holding output of OUT1 turns OFF after one-shot output time of OUT2. One-shot output time of OUT1 is regardless of OUT2 output.	
K [K]	 RESET, 2nd setting, 1st setting, 0, OUT1, OUT2 (OUT)	 RESET, 2nd setting, 1st setting, 0, OUT1, OUT2 (OUT)	After count-up, counting display value increases or decreases until reset signal input is applied. Self-holding output of OUT1 turns OFF after one-shot output time of OUT2. One-shot output time of OUT1 is regardless of OUT2 output.	
P [P]	 RESET, 2nd setting, 1st setting, 0, OUT1, OUT2 (OUT)	 RESET, 2nd setting, 1st setting, 0, OUT1, OUT2 (OUT)	After count-up, counting display value is maintained while OUT2 output is ON. Counting value is internally reset and it counts simultaneously. When OUT2 output is OFF, displays counting value while OUT2 output is ON, and it increases or decreases. Self-holding output of OUT1 turns OFF after one-shot output time of OUT2.	
Q [Q]	 RESET, 2nd setting, 1st setting, 0, OUT1, OUT2 (OUT)	 RESET, 2nd setting, 1st setting, 0, OUT1, OUT2 (OUT)	After count-up, counting display value increases or decreases during one-shot time of OUT2. Self-holding output of OUT1 turns OFF after one-shot output time of OUT2. One-shot output time of OUT1 is regardless of OUT2 output.	
S [S]	<p style="text-align: center;">Up</p> RESET, 2nd setting, 1st setting, 0, OUT1, OUT2 (OUT)	<p style="text-align: center;">Down</p> RESET, 2nd setting, 1st setting, 0, OUT1, OUT2 (OUT)	<ul style="list-style-type: none"> ●Up, Up/Down-A, B, C input mode <ul style="list-style-type: none"> : OUT1 output maintains ON when counting display value is larger or equal than 1st setting value. : OUT2 output maintains ON when counting display value is larger or equal than 2nd setting value. ●Down, Up/Down-D, E, F input mode <ul style="list-style-type: none"> : OUT1 output maintains ON when counting display value is smaller or equal than 1st setting value. : OUT2 output maintains ON when counting display value is smaller or equal than 2nd setting value. 	
	<p style="text-align: center;">Up/Down-A, B, C</p> RESET, 2nd setting, 1st setting, 0, OUT1, OUT2 (OUT)	<p style="text-align: center;">Up/Down-D, E, F</p> RESET, 2nd setting, 1st setting, 0, OUT1, OUT2 (OUT)		
	 RESET, 2nd setting, 1st setting, 0, OUT1, OUT2 (OUT)	 RESET, 2nd setting, 1st setting, 0, OUT1, OUT2 (OUT)		

Up-Down Measure Counter

■ Proper Usage

- Follow instructions in 'Proper Usage'. Otherwise, it may cause unexpected accidents.
- Use the product, 0.1 sec after supplying power.
- When supplying or turning off the power, use a switch or etc. to avoid chattering.
- Install a power switch or circuit breaker in the easily accessible place for supplying or disconnecting the power.
- In case of contact input, set count speed to low speed mode (1cps or 30cps) to operate.
If set to high speed mode (300cps, 2kcps, 5kcps), counting error occurs due to chattering.
- Keep away from high voltage lines or power lines to prevent inductive noise.
In case installing power line and input signal line closely, use line filter or varistor at power line and shielded wire at input signal line.
Do not use near the equipment which generates strong magnetic force or high frequency noise.
- This product may be used in the following environments.
 - ① Indoors (in the environment condition rated in 'Specifications')
 - ② Altitude max. 2,000m
 - ③ Pollution degree 2
 - ④ Installation category II

SENSORS
CONTROLLERS
MOTION DEVICES
SOFTWARE

(J) Temperature Controllers
(K) SSRs
(L) Power Controllers
(M) Counters
(N) Timers
(O) Digital Panel Meters
(P) Indicators
(Q) Converters
(R) Digital Display Units
(S) Sensor Controllers
(T) Switching Mode Power Supplies
(U) Recorders
(V) HMIs
(W) Panel PC
(X) Field Network Devices