

SECTION A-A

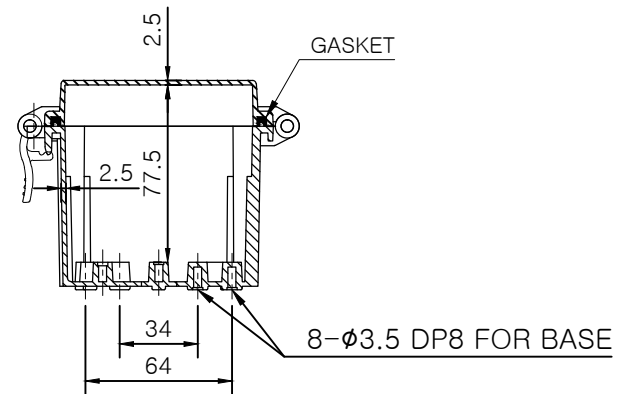
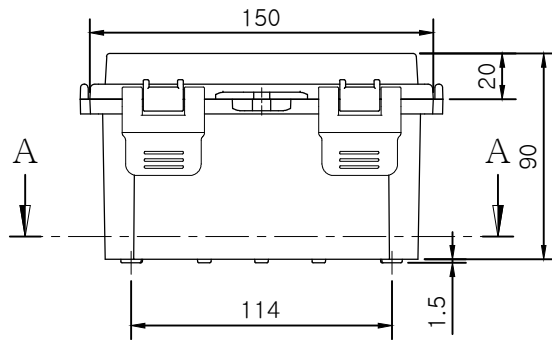

SECTION B-B

Note.

규격 및 사양은 사전 예고 없이 변경될 수 있습니다.

Dimensions and specifications are subject to change without notice.

MODEL (모델)	BC-□□Q-101509		D R (제 도)	JUNG, Y. J.	16.03.00	UNIT (단 위)	mm
ASSY (완성 규격)	100 * 150 * 90		C K (검 도)	PARK, Y. J.	16.03.00	SCALE (척 도)	1:1
DWG NO (도 번)	Q-101509	MATERIAL (재 질)	A P (승 인)	KIM, D. S.	16.03.00	REV. (개 정)	0

