

SECTION A-A

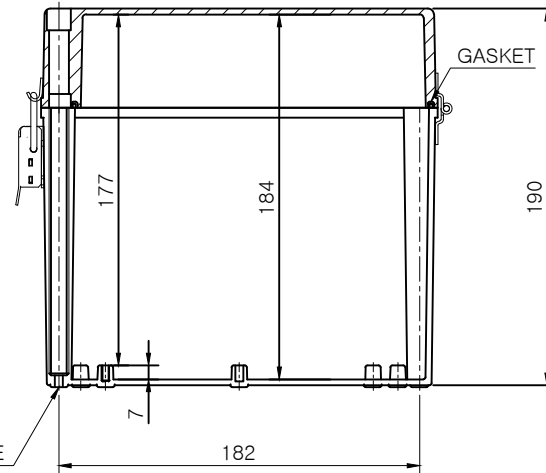
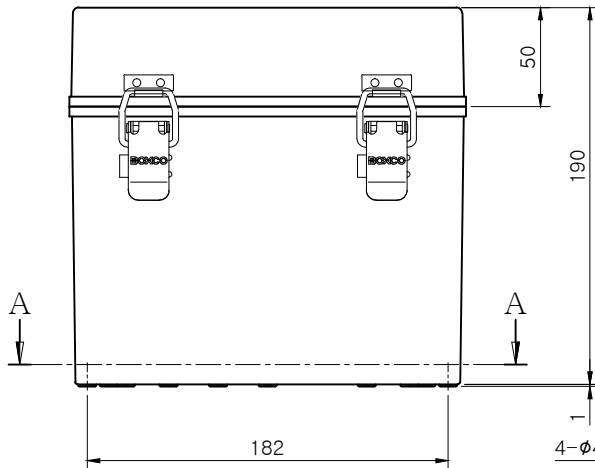

SECTION B-B

**Note.**

\*규격 및 사양은 사전 예고 없이 변경 될 수 있습니다.  
 \*Specifications and Dimensions are subject to change without notice.

MODEL (모델)	BC-□□H-202019		D R (재도)	HWANG,S.M.	21.03.02	UNIT (단위)	mm
ASSY (완성 규격)	200 * 200 * 190		C K (검도)	KIM,S.J.	21.03.02	SCALE (척도)	1:2.5
DWG NO (도번)	H-202019-3	MATERIAL (재질)	A P (승인)	KIM,S.J.	21.03.02	REV. (개정)	0

