

Compact Oil Resistant/Oil Proof Type Photoelectric Sensor

■ Features

- Stronger in the environment with full of cutting fluid or lubricating oil (optimized for automobile and machine tool industry)
BJR (oil resistant type): Special coating prevents penetration of oil into the product.
BJR-F (oil proof type): Even if oil penetrates into the product, it operates normally.
- Long sensing distance with lens of high performance
- Through-beam type: 15m, Diffuse reflective type: 1m,
Polarized retroreflective type: 3m (MS-2S)
- M.S.R. (Mirror Surface Rejection) function (retroreflective type)
- Compact size: W20 × H32 × L11mm
- Light ON/Dark ON operation mode switch
- Sensitivity adjuster
- Built-in reverse polarity protection circuit and output short overcurrent protection circuit
- Mutual interference prevention function (except through-beam type)
- Excellent noise immunity and minimal influence from ambient light
- IP67 protection structure (IEC standard)
BJR (oil resistant type): IP67G oil resistance protection structure (JEM standard)
BJR-F (oil proof type): IP67F oil proof protection structure (JEM standard)

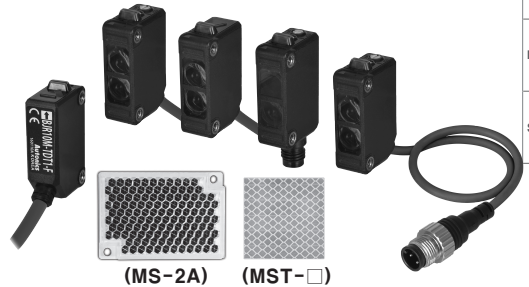

※The model name with '-C' is connector type, and with '-W' is cable connector type.
※MST-□ is sold separately.

⚠ Please read "Safety Considerations" in the instruction manual before using.



■ Specifications

◎ BJR (oil resistant type)

Model	NPN open collector output		BJR15M-TDT-□		BJR3M-PDT-□		BJR1M-DDT-□		BJR100-DDT-□		
	PNP open collector output		BJR15M-TDT-□-P		BJR3M-PDT-□-P		BJR1M-DDT-□-P		BJR100-DDT-□-P		
Sensing type	Through-beam type		Retroreflective type (built-in polarizing filter)		Diffuse reflective type						
Sensing distance	15m		3m ^{*1}		1m ^{*2}		100mm ^{*3}				
Sensing target	Opaque material over Ø12mm		Opaque material over Ø75mm		Translucent, opaque materials						
Hysteresis	—				Max. 20% at sensing distance						
Response time	Max. 1ms										
Power supply	10-30VDC [~] ±10% (ripple P-P: max. 10%)										
Current consumption	Emitter/Receiver: max. 20mA		Max. 30mA								
Light source	Infrared LED (850nm)		Red LED (660nm)		Red LED (660nm)		Infrared LED (850nm)				
Sensitivity adjustment	Sensitivity adjuster										
Operation mode	Light ON / Dark ON selectable by switch										
Control output	NPN or PNP open collector output • Load voltage: Max. 30VDC [~] • Load current: Max. 100mA • Residual voltage - NPN: Max. 1VDC [~] , PNP: Max. 2VDC										
Protection circuit	Power reverse polarity protection circuit, output short over current protection circuit		Power reverse polarity protection circuit, output short over current protection circuit, interference prevention function								
Indicator	Operation indicator: yellow LED, stability indicator: green LED (emitter's power indicator: red LED)										
Connection	Cable type, cable connector type										
Insulation resistance	Over 20MΩ (at 500VDC megger)										
Noise immunity	±240V the square wave noise (pulse width: 1μs) by the noise simulator										
Dielectric strength	1,000VAC 50/60Hz for 1 minute										
Vibration	1.5mm amplitude at frequency of 10 to 55Hz (for 1 min) in each X, Y, Z direction for 2 hours										
Shock	500m/s ² (approx. 50G) in each X, Y, Z direction for 3 times										
Environment	Ambient illu.	Sunlight: max. 11,000lx, incandescent lamp: max. 3,000lx (receiver illumination)									
	Ambient temp.	-25 to 60°C, storage: -40 to 70°C									
	Ambient humi.	35 to 85%RH, storage: 35 to 85%RH									
Protection structure	IP67 (IEC standard), IP67G ^{*4} (JEM standard)										
Material	Case: acrylonitrile-butadiene-styrene, LED Cap: polyamide 12, lens cover: polymethyl methacrylate										
Cable	Cable type	Ø4mm, 3-wire, 2m (emitter of through-beam type: Ø4mm, 2-wire, 2m) (AWG26, core diameter: 0.52mm, number of cores: 20, insulator out diameter: Ø1mm)									
	Cable connector type ^{*6, *7}	Ø4mm, 3-wire, 300mm (emitter of through-beam type: Ø4mm, 2-wire, 300mm), M12 connector (AWG26, core diameter: 0.52mm, number of cores: 20, insulator out diameter: Ø1mm)									
Accessory	Common	Mounting bracket, M3 bolt: 4, adjustment screwdriver		Mounting bracket, M3 bolt: 2, adjustment screwdriver							
	Individual	—		Reflector (MS-2S)		—					
Approval	CE										
Weight ^{*9}	Cable type	Approx. 145g (approx. 95g)		Approx. 115g (approx. 50g)		Approx. 100g (approx. 50g)					
	Cable connector type	Approx. 105g (approx. 55g)		Approx. 95g (approx. 30g)		Approx. 80g (approx. 30g)					

SENSORS

CONTROLLERS

MOTION DEVICES

SOFTWARE

(A) Photoelectric Sensors

(B) Fiber Optic Sensors

(C) LIDAR

(D) Door/Area Sensors

(E) Vision Sensors

(F) Proximity Sensors

(G) Pressure Sensors

(H) Rotary Encoders

(I) Connectors/ Connector Cables/ Sensor Distribution Boxes/ Sockets

BJR Series

◎ BJR-F (oil proof type)

Model	NPN open collector output		BJR10M-TDT-□-F		BJR3M-PDT-□-F		BJR1M-DDT-□-F		BJR100-DDT-□-F		
	PNP open collector output		BJR15M-TDT-□-P-F		BJR10M-TDT-□-P-F		BJR3M-PDT-□-P-F		BJR1M-DDT-□-P-F		BJR100-DDT-□-P-F
Sensing type	Through-beam type				Retroreflective type (built-in polarizing filter)		Diffuse reflective type				
Sensing distance	15m		10m		3m ^{※1}		1m ^{※2}		100mm ^{※3}		
Sensing target	Opaque material over Ø12mm				Opaque material over Ø75mm		Translucent, opaque materials				
Hysteresis	—				Max. 20% at sensing distance						
Response time	Max. 1ms										
Power supply	10-30VDC [—] ±10% (ripple P-P: max. 10%)										
Current consumption	Emitter/Receiver: max. 20mA					Max. 30mA					
Light source	Infrared LED (850nm)		Red LED (660nm)		Red LED (660nm)		Infrared LED (850nm)				
Sensitivity adjustment	Sensitivity adjuster										
Operation mode	Light ON / Dark ON selectable by switch										
Control output	NPN or PNP open collector output • Load voltage: Max. 30VDC [—] • Load current: Max. 100mA • Residual voltage - NPN: Max. 1VDC [—] , PNP: Max. 2VDC										
Protection circuit	Power reverse polarity protection circuit, output short over current protection circuit				Power reverse polarity protection circuit, output short over current protection circuit, interference prevention function						
Indicator	Operation indicator: yellow LED, stability indicator: green LED (emitter's power indicator: red LED)										
Connection	Cable type, Connector type, Cable connector type										
Insulation resistance	Over 20MΩ (at 500VDC megger)										
Noise immunity	±240V the square wave noise (pulse width: 1μs) by the noise simulator										
Dielectric strength	1,000VAC 50/60Hz for 1 minute										
Vibration	1.5mm amplitude at frequency of 10 to 55Hz (for 1 min) in each X, Y, Z direction for 2 hours										
Shock	500m/s ² (approx. 50G) in each X, Y, Z direction for 3 times										
Environment	Ambient illu.	Sunlight: max. 11,000lx, incandescent lamp: max. 3,000lx (receiver illumination)									
	Ambient temp.	-25 to 60°C, storage: -40 to 70°C									
	Ambient humi.	35 to 85%RH, storage: 35 to 85%RH									
Protection structure	IP67 (IEC standard), IP67F ^{※4} (JEM standard)										
Material	Case: acrylonitrile-butadiene-styrene, LED Cap: polyamide 12, lens cover: polymethyl methacrylate										
Cable	Cable type	Ø4mm, 3-wire, 2m (emitter of through-beam type: Ø4mm, 2-wire, 2m) (AWG26, core diameter: 0.52mm, number of cores: 20, insulator out diameter: Ø1mm)									
	Connector type ^{※5}	M8 connector									
	Cable connector type ^{※6}	Ø4mm, 3-wire, 300mm (emitter of through-beam type: Ø4mm, 2-wire, 300mm), M12 connector (AWG26, core diameter: 0.52mm, number of cores: 20, insulator out diameter: Ø1mm)									
Accessory	Common	Mounting bracket ^{※8} , M3 bolt: 4, adjustment screwdriver				Mounting bracket ^{※8} , M3 bolt: 2, adjustment screwdriver					
	Individual	—				Reflector (MS-2S)		—			
Approval	CE										
Weight ^{※9}	Cable type	Approx. 145g (approx. 95g)				Approx. 115g (approx. 50g)		Approx. 100g (approx. 50g)			
	Connector type	Approx. 65g (approx. 12g)				Approx. 75g (approx. 6g)		Approx. 60g (approx. 6g)			
	Cable connector type	Approx. 105g (approx. 55g)				Approx. 95g (approx. 30g)		Approx. 80g (approx. 30g)			

※1: The sensing distance is specified with using the MS-2S reflector. The distance between the sensor and the reflector should be set over 0.1m. When using reflective tapes, the reflectivity will vary by the size of the tape. Please refer to the catalog or website.

※2: Non-glossy white paper 300×300mm.

※3: Non-glossy white paper 100×100mm.

※4: Alphabet represents protection structure for oil resistance/oil proof which is defined according to the JEM.

G: Oil (drop or dust) from any direction never penetrate into the product.

F: The product is not affected by oil (drop or dust) from any direction.

※5: M8 connector cable is sold separately. (AWG26, core diameter: 0.1mm, number of cores: 20, insulator out diameter: Ø1mm)

※6: M12 connector cable is sold separately. (AWG22, core diameter: 0.08mm, number of cores: 60, insulator out diameter: Ø1.65mm)

※7: Although some of the cable connector type products can have color difference in the connector part due to the coating, it does not affect operation and performance.

※8: Cable type and cable connector type includes bracket A and connector type includes bracket B.

※9: The weight includes packaging. The weight in parenthesis is for unit only.

※The temperature or humidity mentioned in Environment indicates a non freezing or condensation.

■ Oil Resistance/Oil Proof Test

For IP67G, IP67F protection structure, we conducted reliability test on the oil in the following table, and got a result of pass.

When reviewing the oil to be used, refer to the following table.

Oil type	JIS standard	Oil name	Kinetic viscosity (mm ² /s, 40°C)	PH
Lubricating oil	—	Velocite Oil No.3	2	—
Water-insoluble cutting fluid	2-5	Tectyl Cut 527	27	—
Water-soluble cutting fluid	—	Tectyl Cool 263C	—	9.5 (10% Solution)

● Result of dropping test for 240 hours with the above oil

- BJR (oil resistant type): Special coating prevents penetration of oil into the product. It obtains IP67G (JEM standard) protection structure of enhanced oil resistance.

- BJR-F (oil proof type): Even if oil penetrates into the product, it operates normally. It obtains IP67F (JEM standard) protection structure of enhanced oil proof.

Compact Oil Resistant/Oil Proof Type

■ Feature Data

- © BJR (oil resistant type)
- Through-beam type
- BJR15M-TDT-(C)-(P)

Parallel shifting characteristic		Emitter angle characteristic		Receiver angle characteristic	
Measuring method	Data	Measuring method	Data	Measuring method	Data

- Retroreflective type
- BJ3M-PDT-(C)-(P)

Parallel shifting characteristic		Sensor angle characteristic		Reflector angle characteristic	
Measuring method	Data	Measuring method	Data	Measuring method	Data

- Diffuse reflective type
- BJR1M-DDT-(C)-(P)

Sensing area characteristic	
Measuring method	Data

- BJR100-DDT-(C)-(P)

Sensing area characteristic	
Measuring method	Data

SENSORS

CONTROLLERS

MOTION DEVICES

SOFTWARE

(A) Photoelectric Sensors

(B) Fiber Optic Sensors

(C) LIDAR

(D) Door/Area Sensors

(E) Vision Sensors

(F) Proximity Sensors

(G) Pressure Sensors

(H) Rotary Encoders

(I) Connectors/ Connector Cables/ Sensor Distribution Boxes/ Sockets

BJR Series

- BJR-F (oil proof type)
- Through-beam type
- BJR15M-TDT-(C)-(P)-F

Parallel shifting characteristic		Emitter angle characteristic		Receiver angle characteristic	
Measuring method	Data	Measuring method	Data	Measuring method	Data

- BJR10M-TDT-(C)-(P)-F

Parallel shifting characteristic		Emitter angle characteristic		Receiver angle characteristic	
Measuring method	Data	Measuring method	Data	Measuring method	Data

● Retroreflective type

- BJ3M-PDT-(C)-(P)-F

Parallel shifting characteristic		Sensor angle characteristic		Reflector angle characteristic	
Measuring method	Data	Measuring method	Data	Measuring method	Data

● Diffuse reflective type

- BJR1M-DDT-(C)-(P)-F

Sensing area characteristic	
Measuring method	Data

- BJR100-DDT-(C)-(P)-F

Sensing area characteristic	
Measuring method	Data

Compact Oil Resistant/Oil Proof Type

■ Connections

◎ Cable type

● Through-beam type

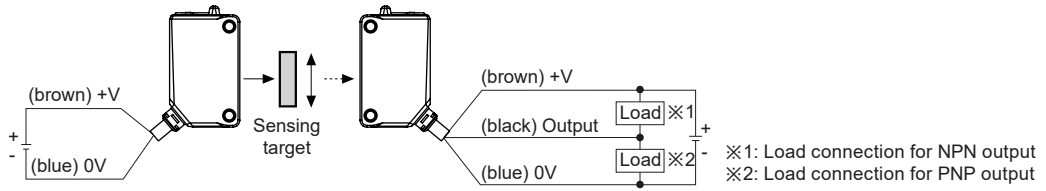

● Retroreflective type

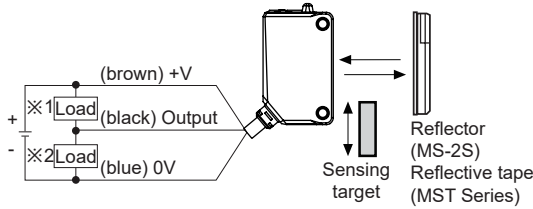

● Diffuse reflective type

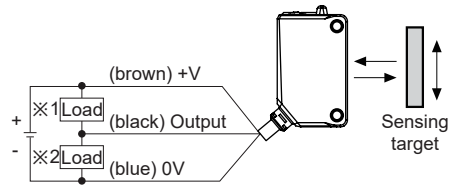

◎ Connections for connector part

● Connector type (BJR-F)

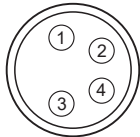

[M8 connector pin]

Connections for cable connector part			
Connector pin No.	Cable colors	Functions	Etc.
①	Brown	Power Source (+V)	Connector cable (sold separately) • CIDH408-□ • CLDH408-□
②	White	N-C	
③	Blue	Power Source (0V)	
④	Black	Output	

※Connector pin ② is N-C (Not Connected) terminal.

● Cable connector type

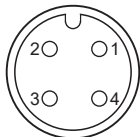

[M12 connector pin]

Connections for cable connector part			
Connector pin No.	Cable colors	Functions	Etc.
①	Brown	Power Source (+V)	Connector cable (sold separately) • CIDH4-□ • CLDH4-□
②	White	N-C	
③	Blue	Power Source (0V)	
④	Black	Output	

※Connector pin ② is N-C (Not Connected) terminal.

■ Control Output Diagram

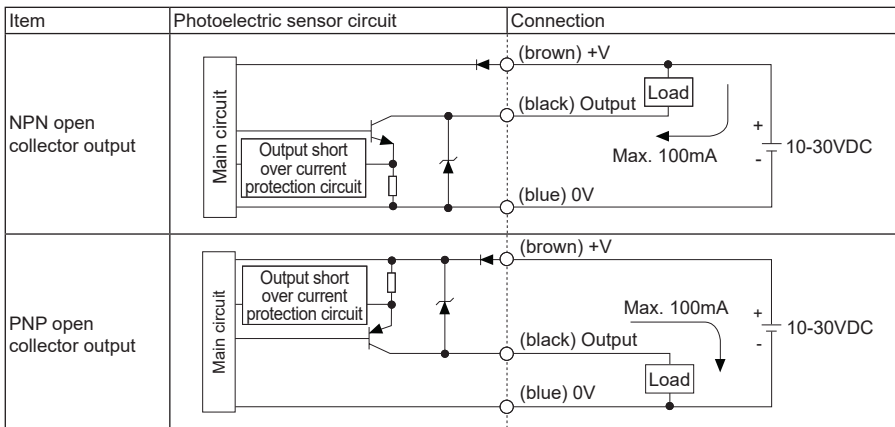

※If short-circuit the control output terminal or supply current over the rated specification, normal control signal is not output due to the output short over current protection circuit.

SENSORS
CONTROLLERS
MOTION DEVICES
SOFTWARE
(A) Photoelectric Sensors
(B) Fiber Optic Sensors
(C) LIDAR
(D) Door/Area Sensors
(E) Vision Sensors
(F) Proximity Sensors
(G) Pressure Sensors
(H) Rotary Encoders
(I) Connectors/ Connector Cables/ Sensor Distribution Boxes/ Sockets

BJR Series

(unit: mm)

■ Dimensions

◎ Cable type

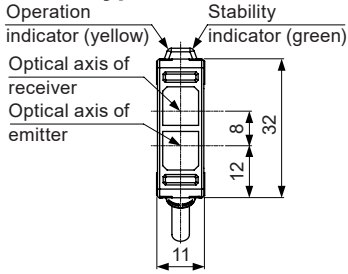

[Retroreflective/Diffuse type]

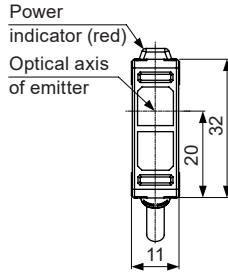

[Through-beam type (emitter)]

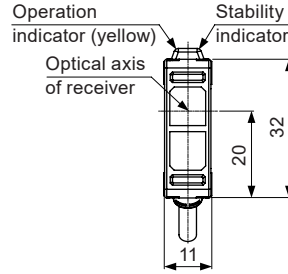

[Through-beam type (receiver)]

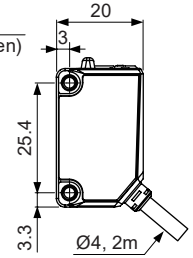

◎ Cable connector type

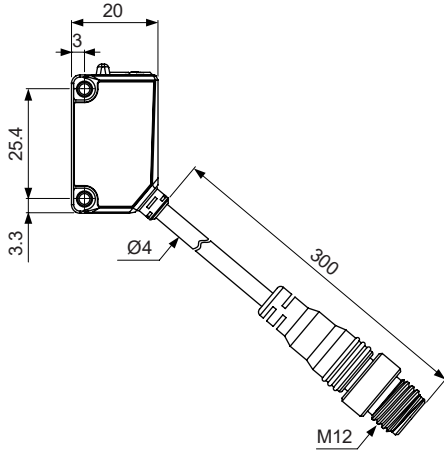

● Bracket A

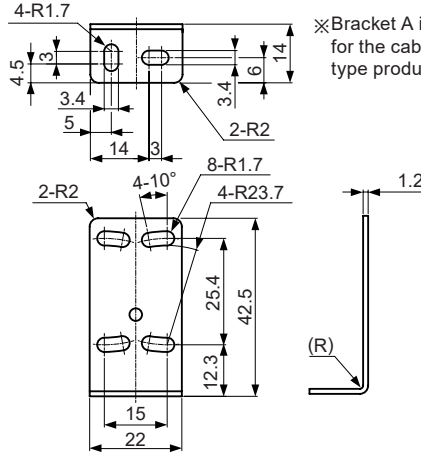

※Bracket A is provided as an accessory for the cable type and cable connector type product.

◎ Connector type (BJR-F)

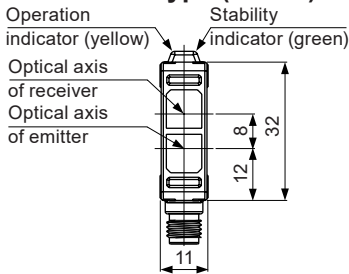

[Retroreflective/Diffuse type]

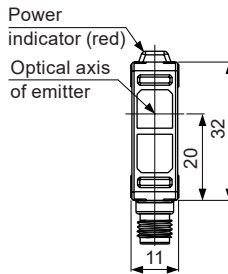

[Through-beam type (emitter)]

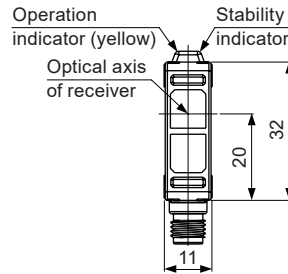

[Through-beam type (receiver)]

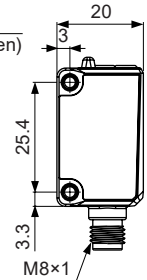

● Bracket B (BK-BJP-B)

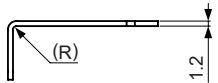

※Bracket B is provided as an accessory for the connector type product.
※It can be purchased separately.

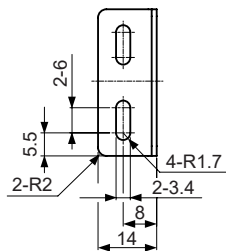
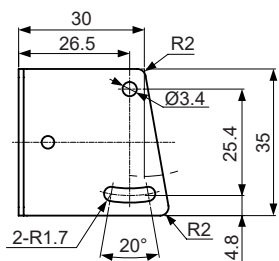

● Reflector (MS-2S)

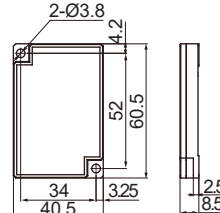

● Reflective tape (sold separately)

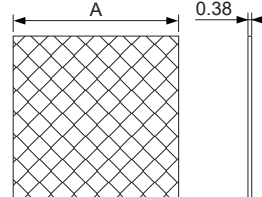

Model	A
MST-50-10	□50
MST-100-5	□100
MST-200-2	□200

Compact Oil Resistant/Oil Proof Type

■ Operation Mode

Operation mode	Light ON	Dark ON
Receiver operation	Received light Interrupted light	Received light Interrupted light
Operation indicator (red LED)	ON OFF	ON OFF
Transistor output (NPN/PNP)	ON OFF	ON OFF

■ Operation Timing Diagram

◎ Through-beam type

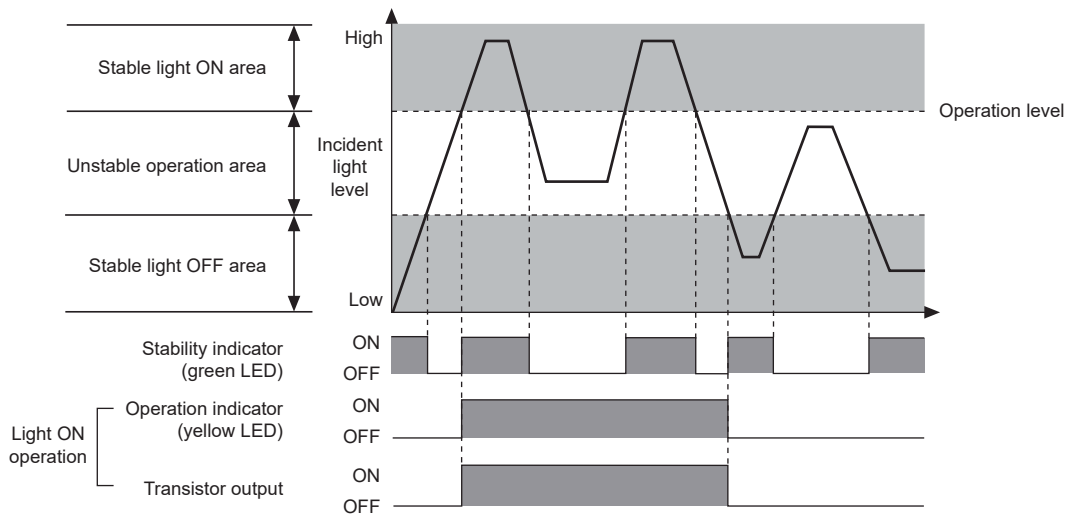

◎ Retroreflective type/Diffuse reflective type

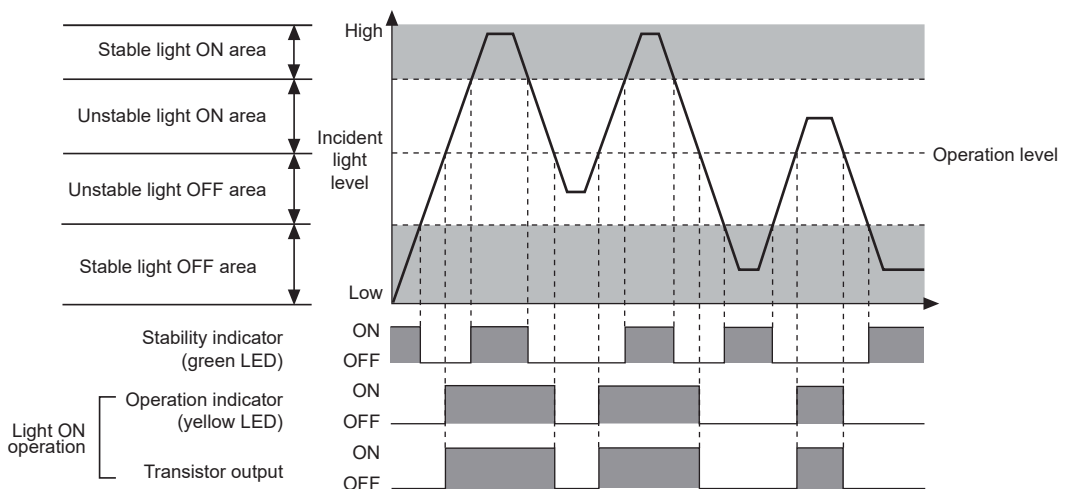

※The waveforms of 'Operation indicator' and 'Transistor output' are for Light ON operation. The waveforms are reversed for Dark ON operation.

SENSORS

CONTROLLERS

MOTION DEVICES

SOFTWARE

(A) Photoelectric Sensors

(B) Fiber Optic Sensors

(C) LIDAR

(D) Door/Area Sensors

(E) Vision Sensors

(F) Proximity Sensors

(G) Pressure Sensors

(H) Rotary Encoders

(I) Connectors/ Connector Cables/ Sensor Distribution Boxes/ Sockets

■ Installation and Adjustment

○ For mounting

When using the reflective type photoelectric sensors closely over three units, it may result in malfunction due to mutual interference. When using the through-beam type photoelectric sensors closely over two units, it may result in malfunction due to mutual interference.

When installing the product, tighten the screw with a tightening torque of 0.5 N·m.

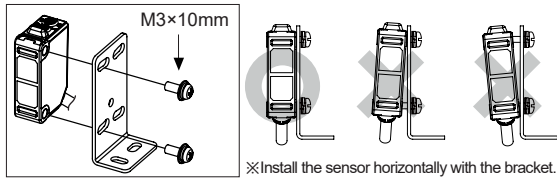

○ Optical axis adjustment

● Through-beam type

- Place the emitter and the receiver facing each other and supply the power.
- After adjusting the position of the emitter and the receiver and check their stable indicating range, mount them in the middle of the range.
- After mounting this unit, check the operation of the sensor and lighting of the stability indicator in both status. (none or sensing target status)

※If the sensing target is translucent body or smaller than $\varnothing 15\text{mm}$, it may not sense the target because light is passed.

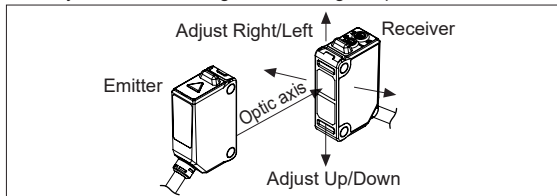

● Retroreflective type

- Place the sensor and the reflector (or reflective tape) facing each other and supply the power.
- After adjusting the position of the sensor and reflector (or reflective tape) and checking their stable indicating range, mount them in the middle of the range. (none or sensing target status)
- After mounting this unit, check the operation of the sensor and in both status. (none or sensing target status)

※Please use reflective tape (MST Series) for where a reflector is not installed.

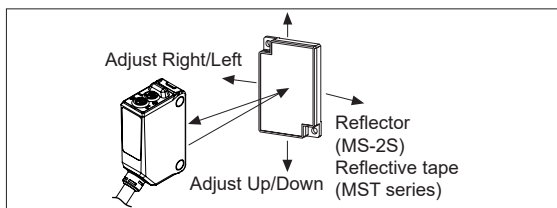

● Diffuse reflective type

- Place the emitter and the receiver facing each other and supply the power.
- After adjusting the position of the emitter and the receiver and check their stable indicating range, mount them in the middle of the range.
- After mounting this unit, check the operation of the sensor and lighting of the stability indicator in both status. (none or sensing target status)

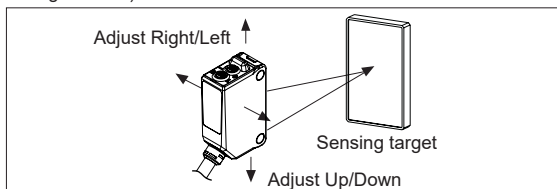

○ Operation mode switching

Light ON		Turn the switch all the way to the right (towards L) to select Light ON operation.
Dark ON		Turn the switch all the way to the left (towards D) to select Dark ON operation.

※For through-beam type, the switch is built-in the receiver.

○ Sensitivity adjustment

Order	Sensitivity setting	Descriptions
1		From Light ON status, turn the sensitivity setting adjuster slowly to the right from MIN sensitivity and check the position where operation indicator turns on (A).
2		From Dark ON status, turn the sensitivity setting adjuster further right and check the position where the operation indicator turns on (B). Turn the adjuster left and check the position where the operation indicator turns off (C). ※If the operation indicator does not turn on at MAX sensitivity, the maximum sensitivity setting is set at position (C).
3		Set the adjuster at the center position between (A) and (C) for optimal sensitivity. Also, check if the stability indicator turns off with or without the sensing target. If it does not turn off, please review the operation mode again, as sensitivity may be unstable.

	Light ON	Dark ON
Through-beam type		
Retro-reflective type		
Diffuse reflective type		

※Please set the sensitivity setting adjuster is executed in stable Light ON area and the reliability of environment (temperature, supply, dust etc.) is increased after the mounting it in a stable area.

※When adjusting sensitivity or switching operation modes, please use the Autonics adjustment screwdriver (included accessory). Using a screwdriver with a bigger diameter than the adjuster buttons may cause errors when making adjustments.

※ It may cause breakdown when the sensitivity setting adjuster or the operation mode selection switch is turned by force.

■ Reflectivity by Reflective Tape Model

MST-50-10(50×50mm)	35%
MST-100-5(100×100mm)	45%
MST-200-2(200×200mm)	55%

※This reflectivity is based on the reflector (MS-2S).

※Reflectivity may vary depending on usage environment and installation conditions.

The sensing distance and minimum sensing target size increase as the size of the tape increases.

Please check the reflectivity before using reflective tapes.

※For using reflective tape, installation distance should be min. 20mm.