

ARD-A Series

DeviceNet Analog Remote I/O

■ Features

- Adopts DeviceNet, standard open Network
 - : Communicates other DeviceNet devices without additional installations
 - : Configurable power and communication system only with communication cables
 - : Connectable max. 63 units per 1 master unit
- Strong against noise and high accuracy (0.3%) measurement with differential input method (measuring difference between +, - input signal)
- Various I/O range: 0-5VDC, 1-5VDC, 0-10VDC, -5-5VDC, -10-10VDC, DC4-20mA, DC0-20mA
- Scale function: Settable high/low limit scale value for analog I/O range (Setting range: -28,000 to 28,000)
- Various functions
 - : Automatic communication speed recognition, Network voltage monitoring, Input digital filter, Peak/Bottom Hold, hysteresis, reading model name and number of units, I/O and status flag monitoring
- Built-in surge, ESD protection, Reverse polarity protection circuit
- Mounting DIN rail method and bolt mounting method



⚠ Please read "Safety Considerations" in the instruction manual before using.

CE **DeviceNet™**
CONFORMANCE TESTED
(only for ARD-AI04,
other models are compatible)

■ Ordering Information

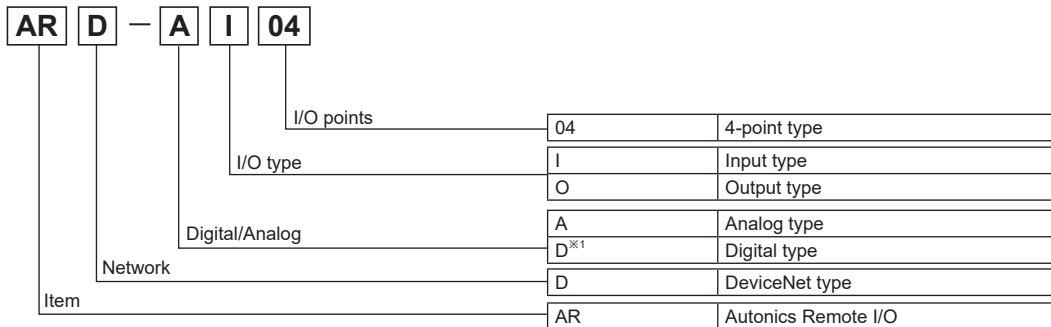

※1. For digital type, refer to 'ARD-D Series'.

■ Manual

For the detail information please refer to the user manual and be sure to follow cautions written in the technical descriptions (catalog, website).

Visit our website (www.autonics.com) to download manuals.

■ Analog I/O Specifications

No.	I/O range	Max. allowable I/O range
0	0-5VDC	-0.25-5.25VDC
1	1-5VDC	0.8-5.2VDC
2	0-10VDC	-0.5-10.5VDC
3	-5-5VDC	-5.5-5.5VDC
4	-10-10VDC	-11-11VDC
5	DC4-20mA	DC3.2-20.8mA
6	DC0-20mA	DC0-21mA

DeviceNet Analog Remote I/O

■ Specifications

Model	ARD-AI04		ARD-AO04	
Power supply	Rated voltage: 24VDC \pm , Voltage range: 12-28VDC \pm			
Power consumption	Max. 3W			
I/O points	Input 4-point (switchable voltage/current)		Output 4-point (voltage 2CH, current 2CH)	
Control I/O	Voltage	0-10VDC \pm , -10-10VDC \pm , 0-5VDC \pm , 1-5VDC \pm , -5-5VDC \pm (input impedance: max. 1M Ω)		0-10VDC \pm , -10-10VDC \pm , 0-5VDC \pm , 1-5VDC \pm , -5-5VDC \pm (load resistance: max. 1k Ω)
	Current	DC4-20mA, DC0-20mA (input impedance: 250 Ω)		DC4-20mA, DC0-20mA (load resistance: max. 600 Ω)
	Max. allowable range	\pm 5% F.S of rated input range		\pm 5% F.S of rated output range
	Resolution	14bit, 1/16,000		
Accuracy	● At room temperature (25 \pm 5 $^{\circ}$ C) range: \pm 0.3% F.S. ● Out of room temperature range: \pm 0.6% F.S.			
Insulation resistance	Over 200M Ω (at 500VDC megger)			
Noise immunity	\pm 240V the square wave noise (pulse width: 1 μ s) by the noise simulator			
Dielectric strength	500VAC 50/60Hz for 1 min (between external terminals and case, between I/O and power terminals)			
Vibration	1.5mm amplitude at frequency of 10 to 55Hz (for 1 min) in each X, Y, Z direction for 2 hours			
Shock	500m/s 2 (approx. 50 G) in each X, Y, Z direction for 3 times			
Environ- ment	Ambient temperature	-10 to 50 $^{\circ}$ C, storage: -25 to 75 $^{\circ}$ C		
	Ambient humidity	35 to 85%RH, storage: 35 to 85%RH		
Protection structure	IP20 (IEC standard)			
Protection circuit	Surge, ESD protection, reverse polarity protection circuit			
Indicator	Network status (NS) LED (green, red), unit status (MS) LED (green, red)			
Material	Front case, body case: Polycarbonate			
Mounting	DIN rail or bolt mounting type			
Isolation type	I/O and inner circuit: non-insulated, DeviceNet and inner circuit: insulated, power and DeviceNet: insulated			
Approval	CE <i>DeviceNet</i>		CE , DeviceNet compatible	
Weight *1	Approx. 210g (approx. 145g)			

※Environment resistance is rated at no freezing or condensation.

※1. The weight includes packaging. The weight in parentheses is for unit only.

■ DeviceNet Communication

Item	Specifications
Communication	I/O Slave messaging (Group 2 Only slave) ● Poll command: Yes ● Bit_strobe command: Yes ● Cyclic command: Yes ● COS command: Yes
Communication distance	Max. 500m (125kbps), Max. 250m (250kbps), Max. 100m (500kbps)
NODE ADDRESS setting	Max. 64 nodes
Communication speed *1	125, 250, 500kbps (automatically set when connecting with Master)
Insulation	I/O and inner circuit: Non-insulation, DeviceNetand inner circuit: Insulation, DeviceNet power: Insulation
Approval	ODVA Conformance conformance: ARD-AI04 ODVA Conformance compatible : ARD-AO04

※1. The communication speed is automatically set to the communication speed of the Master (PC, PLC, etc.) When changing the communication speed during operation, the network status (NS) LED flashes in red and communication is not possible.

SENSORS

CONTROLLERS

MOTION DEVICES

SOFTWARE

(J)
Temperature
Controllers

(K)
SSRs

(L)
Power
Controllers

(M)
Counters

(N)
Timers

(O)
Digital
Panel Meters

(P)
Indicators

(Q)
Converters

(R)
Digital
Display Units

(S)
Sensor
Controllers

(T)
Switching
Mode Power
Supplies

(U)
Recorders

(V)
HMIs

(W)
Panel PC

(X)
Field Network
Devices

ARD-A Series

Unit Descriptions

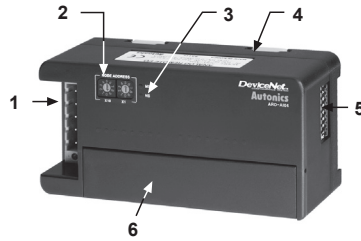

1. DeviceNet connector

No.	Color	For	Organization
5	Red	24VDC (+)	
4	White	CAN_H	
3	None	SHIELD	
2	Blue	CAN_L	
1	Black	24VDC (-)	

2. Rotary switch for node address : Two rotary switches are used for setting node address.

X10 switch represents the 10's multiplier and X10 switch represents the 1's multiplier.

3. Status LED: It is LED for displaying Unit status (MS) and Network status (NS).

4. Rail Lock: It is used for mounting DIN rail or with bolt.

5. DIP switch: It is used for set I/O range. (factory default: all switches are OFF)

(●: ON, -: OFF)

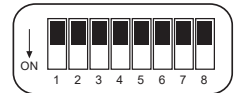

	ARD-AI04 (Input model)						ARD-AO04 (output model)						SW7		SW8 ^{※1}
	CH0, CH1			CH2, CH3			CH0, CH1			CH2, CH3					
I/O range	SW1	SW2	SW3	SW4	SW5	SW6	SW1	SW2	SW3	SW4	SW5	SW6	SW7	SW8 ^{※1}	
0-5VDC	—	—	—	—	—	—	—	—	—	Not supported	—	—	Not supported (Off Setting)	ON Using DIP switch	
1-5VDC	●	—	—	●	—	—	●	—	—						
0-10VDC	—	●	—	—	●	—	—	●	—						
-5-5VDC	●	●	—	●	●	—	●	●	—						
-10-10VDC	—	—	●	—	—	●	—	—	●	Not supported	—	—	Not supported (Off Setting)	OFF Not using DIP switch	
DC4-20mA	●	—	●	●	—	●	Not supported								—
DC0-20mA	—	●	●	—	●	●	Not supported			●	—	—			

※1: By turning ON SW8, I/O range is set by DIP switches (SW1 to SW6). By turning OFF SW8, I/O range is set by communication.

When setting I/O range by DIP switches, CH0 and CH1 (CH2 and CH3) cannot be set individually.

When setting it by communication, each channel is set individually.

6. I/O Terminal block: It is terminal block for connecting external device I/O.

DeviceNet Analog Remote I/O

■ Status LED

※Status of MS LED, NS LED

(☀: ON, ⚡: Flash, ●: OFF)

No.	Type	LED status	Color	Descriptions	Troubleshooting
1	MS	☀	Green	Normal operation I/O communication or message communication is working.	—
	NS	☀	Green		
2	MS	☀	Green	Standby of duplicated address The status of standby for receiving message of duplicated address check from master unit.	—
	NS	●	—		
3	MS	☀	Green	Standby of normal operation The status of standby for establish connection from master unit.	—
	NS	⚡	Green		
4	MS	☀	Red	Watchdog timer error The status that DIP switch or another switch setting is invalid.	Change the switch with valid value and re-supply the power.
	NS	●	—		
5	MS	⚡	Red	Switch setting error The status that DIP switch or another switch setting is invalid.	Change the switch setting to valid value and re-supply the power.
	NS	●	—		
6	MS	⚡	Red	Changed address during normal operation The status that address is changed during normal operation.	Change the initial address at the power applied at first.
	NS	☀	Green		
7	MS	☀	Green	Invalid address The status of setting invalid address	Change the valid address and re-supply the power.
	NS	☀	Red		
8	MS	☀	Red	Duplicated address There is duplicated address in the network. Occuring Bus-Off error Communication is stopped with Bus-Off.	Change node address not duplicated. Power on the slave unit again. Check master unit, communication, cable, terminating resistance and noise of network.
	NS	☀	Red		
9	MS	☀	Green	I/O Connection time out	Check the master setting and the user program.
	NS	⚡	Red		

■ Dimensions

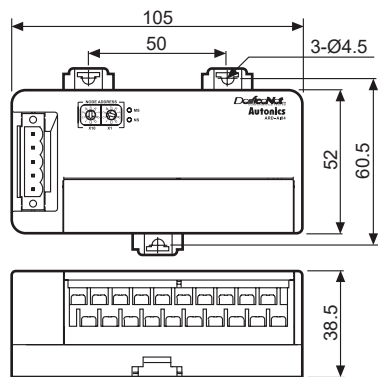

●Panel cut-out

(unit: mm)

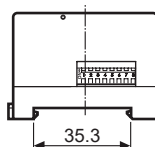
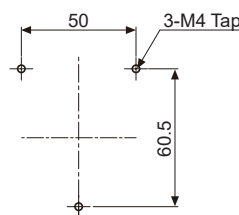

SENSORS

CONTROLLERS

MOTION DEVICES

SOFTWARE

(J)
Temperature
Controllers

(K)
SSRs

(L)
Power
Controllers

(M)
Counters

(N)
Timers

(O)
Digital
Panel Meters

(P)
Indicators

(Q)
Converters

(R)
Digital
Display Units

(S)
Sensor
Controllers

(T)
Switching
Mode Power
Supplies

(U)
Recorders

(V)
HMIs

(W)
Panel PC

(X)
Field Network
Devices

ARD-A Series

I/O Circuit Diagram

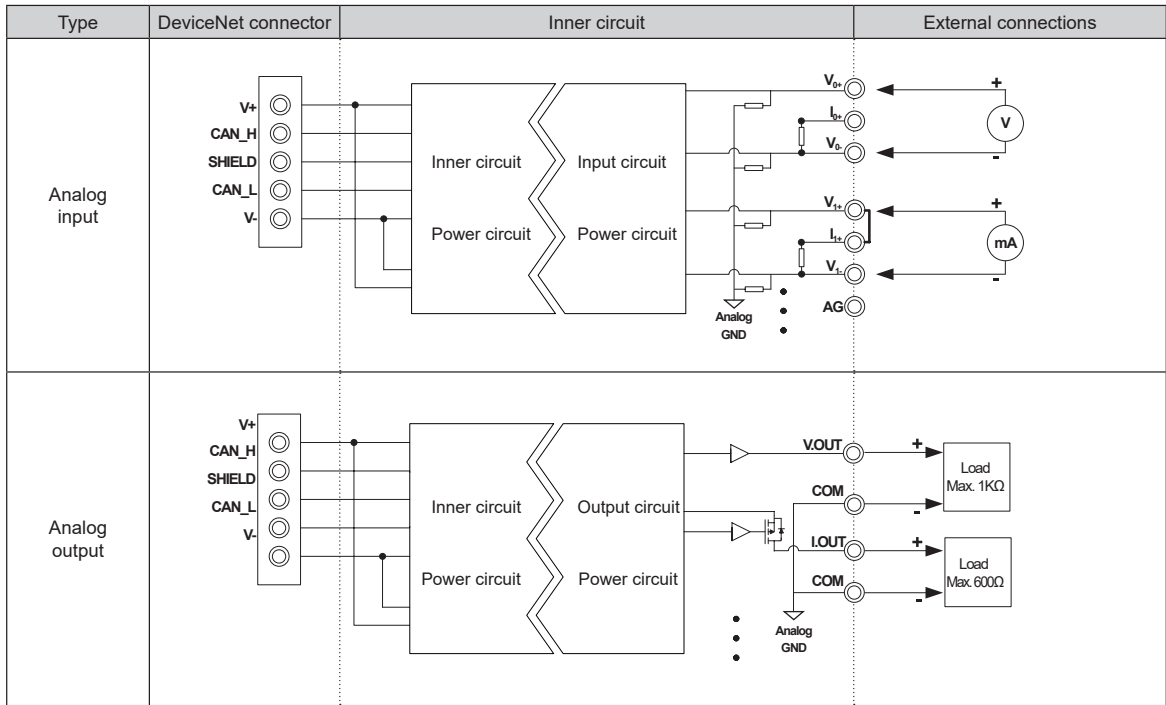

Connections

※When wiring the communication connector, use cable and tap which meet the DeviceNet standard and tighten the connector screw with a tightening torque of 0.5N·m.

※When wiring the input/output terminal, tighten the connector screw with a tightening torque of 0.5N·m.

●ARD-AI04

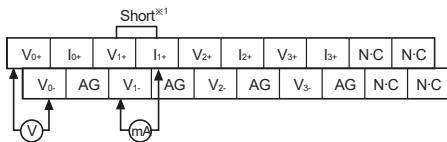

※1: For current input, short between V_{0+} and I_{0+} .

●ARD-AO04

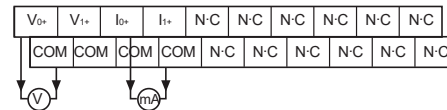

Voltage	0-5VDC
	1 to 5VDC
	-5-5VDC
	0-10VDC
Current	-10-10VDC
	DC0-20mA
	DC4-20mA

Terminating Resistance

- 120Ω
- 1% of metallic film
- 1/4W

※Do not install terminating resistance on ARD unit or it may cause network problem (impedance can be too high or low) or malfunction.

※Connect terminating resistance on the both ends of the trunk line.

Communication Distance

Baud Rate	Max. network length	Max. length of branch line	Allowable expansion length of branch line
125kbps	500m	6m	156m
250kbps	250m	6m	78m
500kbps	100m	6m	39m

■ Setup and Installation

○ Node address setup

- Two rotary switches are used for setting node address.
X10 switch represents the 10's multiplier and X10 switch represents the 1's multiplier.
Node address is settable from 0 to 63.
- Node address is changed when re-supplying the power to the unit.
After changing node address, must re-supply the power.

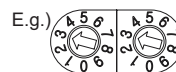

E.g.) The X10 and X1 switches point "3", the address is "33".

※The address of the connected unit must not be duplicated.

When changing the address during operation, the unit status (MS) LED flashes in red and the unit communicates to the address before the change.

○ Installation

● Mounting on panel

- Pull Rail Locks (3) on the rear part of a unit, there are fixing bolt hole.
- Place the unit on a panel to be mounted.
- Make a hole on a fixing bolt position.
- Fasten the bolt to fix the unit tightly.
Tightening torque should be below 0.5N·m.

● Mounting on DIN rail

- Pull two Rail Locks on the rear part of unit.
- Place the unit on DIN rail to be mounted.
- Press Rail Locks to fix the unit tightly.

○ I/O cable connection

Refer to '■ I/O circuit diagram and connections'.

Connect a sensor or the signal cable of external I/O device to the terminal block. (tightening torque: 0.5N·m)

○ DeviceNet cable connection

- For stable system, it is recommended to use the DeviceNet dedicated cable.
- Connect the DeviceNet cable to the DeviceNet connector and tighten the fixed bolt of the connector by a driver. (tightening torque: 0.5N·m)
- Connect the DeviceNet connector to ARD unit and supply the power to Network.

Master unit

PIN No.	Signal
5	V+
4	CAN_H
3	SHIELD
2	CAN_L
1	V-

Red
White
None
Blue
Black

ARD unit

PIN No.	Signal
5	V+
4	CAN_H
3	SHIELD
2	CAN_L
1	V-

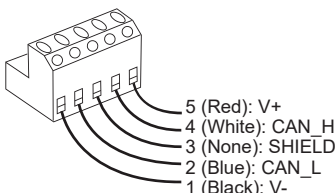

○ Setting of master unit

- Check the LED status of ARD unit when power is supplied. Normal operation is below.

Type	Status LED	Status descriptions
Unit status (MS) LED	Green LED is ON	When master unit status is communication standby: NS LED flashes
Network status (NS) LED	Green LED is ON/flashes	When master unit setting is completed: NS LED is ON.

- Install the software provided by master unit manufacturing company.
- Set communication speed and address in the software.
 - Baud rate: 125/250/500kbps
 - Address of master unit: Usually it is set 00 address.
- Register connected unit on Network to the master unit.
 - There are two ways to register units; automatically register in on-line or manually register in off-line. (Refer to the manual of master unit.)
 - I/O assignment of ARD Series: Usually it is automatically assigned by the setting software.
 - Setting of operation mode: Select among Poll, COS, Cyclic, Bit Strobe. (Usually set Poll mode.)

○ Check operating status

When installation and setting are complete, unit status (MS) LED and Network status (NS) LED turn ON green. (Refer to '■ Status LED'.)

SENSORS
CONTROLLERS
MOTION DEVICES
SOFTWARE

(J) Temperature Controllers

(K) SSRs

(L) Power Controllers

(M) Counters

(N) Timers

(O) Digital Panel Meters

(P) Indicators

(Q) Converters

(R) Digital Display Units

(S) Sensor Controllers

(T) Switching Mode Power Supplies

(U) Recorders

(V) HMIs

(W) Panel PC

(X) Field Network Devices

ARD-A Series

■ Functions

Model		ARD-AI04 (input model)	ARD-AO04 (output model)
Basic	Com. speed auto-recognition		●
	Network power voltage monitoring		●
	Unit power on total time monitoring		●
	Unit comment		●
	Last maintenance data stored		●
Analog	Scaling		●
	I/O comment		●
	Adjustment gradient		●
	Adjustment offset		●
	Input conversion points setting	●	—
	Input digital filter	●	—
	Peak/Bottom hold	●	—
	Disconnected cable detection	●	—
	Input comparison	●	—
	Hysteresis	●	—
	Output setting for error	—	●

○ Communication speed auto-recognition

It recognizes communication speed when connecting master. Communication speed is able to change only from master unit.

After changing communication speed, re-supply the network power to apply the changed communication speed.

○ Network power voltage monitoring

- If network power voltage is lower than the set value, the network power voltage drop flag bit of Status bit is ON. It can be read by Configurator or Explicit message.
- Set monitoring voltage by Explicit message at Network Power voltage (Set Value) of Application Object.
- Setting range: 0 to 255
(factory default: 12V, Allowable range: $\pm 1V$)
- ※ Min. supplied power is 12V for ARD unit.
If network voltage is lower than 12V, the contents of Explicit message reading is not guaranteed.

○ Unit power on total time monitoring

- When total time for supplying power to the unit becomes the SV, Threshold Run Hours Flag bit of Status Bit turns ON. It can be read by Configurator or Explicit message.
- Set the time by Explicit message at Threshold Run Hour of Application Object.
- Setting range: 0 to 429,496,729 hours
(factory default: 876,000 hours),
Measured unit: 0.1 hours (6 minutes)

○ Unit comment

- You can set the comments for the unit (product description) on network. It can be read by Configurator or Explicit message.
- Set comment by Explicit message at Unit Comment of Application Object.
- Setting range: max. 32 characters

○ Last maintenance date

- It saves the last date of maintenance. It can be read/written by Configurator or Explicit message.
- Set maintenance date by Explicit message at I/O Last Maintenance Data Setting of Analog Input Point Object. E.g.)Data: 0x07DB020E→07DB (2011), 02 (February), 0E (14th)

○ Input conversion points setting

- Conversion cycle is changed by the number of points (point, channel).
(conversion cycle: 1ms/point, when using 4 points, it is 4ms). It can be read/written by Configurator or Explicit message. After changing the number of conversion points, re-supply the network power.
- Set the number of conversion points by Explicit message at Number of AD Conversion Points Setting of Analog Input Point Object.
- Setting range: 1 to 4-point (factory default: 4-point), conversion cycle: 1ms/1-point

○ Display scale

- Set high/low-limit scale value of analog input or output. It can be read by Configurator or Explicit message.

Default Scaling	Function Choice : Scaling Flag bit ON Scaling Type : Default Scaling (factory default)	It is set as 1,000 per 1V (mA). In case of 1-5V, 4-20mA, it is applied from over min. allowable range 0.8V (800), 3.2 (3,200). The below input value is break detection. It outputs as min. allowable range.
None Scaling	Function Choice : Scaling Flag bit OFF Scaling Type : Default Scaling	It is set as default value 0 to 16000 (-8000 to 8000). (0-5V, 1-5V, 0-10V, 4-20mA, 0-20mA: 0 to 16000, -5-5V, -10-10V: -8,000 to 8,000)
User Scaling	Function Choice : Scaling Flag bit ON Scaling Type : User Scaling	Set high/low-limit value to apply at 'Scaling Point 0%' and 'Scaling Point 100%'. Setting range: -28,000 to 28,000

○ I/O comment

- You can set the comment for I/O. It is able to read/write by Configurator or Explicit message.
- Set I/O comment by Explicit message at I/O Comment of Analog Input Point Object, Analog Output Point Object.
- Setting range: max. 32 characters

○ Gradient adjustment

- It adjusts the gradient of input/output value or scale value. It is able to read/write by Configurator or Explicit message.
- It is applied when Adjust Gradient Flag bit is set as ON at Function Choice of Analog Input Point Object. Set the range at Adjustment Gradient value.
- Adjustment range: -5 to 5%,
Setting range: -500 to 500 (factory default: 0)
E.g.)When input value is 1000, Adjustment Gradient is 500 (+5%) $X' = aX$, $a = 1 + \text{Adjustment Gradient} (0.05)$,
 $X = 1000$, $X' = 1.05 \times 1000 = 1050$

○ Offset adjustment

- This function is to adjust the error occurring from external analog sensor, etc, not from the unit itself. It is also applied to analog output. It is able to read/write by Configurator or Explicit message.
- It is applied when Adjustment Offset Flag bit is set as ON at Function Choice of Analog Input Point Object. Set the value at Adjustment Offset Value.
- Adjustment range: -5 to 5%,
Setting range: -500 to 500 (factory default: 0)
E.g.)When input range is 0 to 10V, Full Scale 0 to 16000, input value is 1600 (1V) and Adjustment Gradient 500 (+5%), $X' = X + b$, $X = 1600$, $b = 16000 \times 0.05$ (added input value and percentage of Full Scale)
 $X' = 1600 + 800 = 2400 (1.5V)$

○ Input digital filter

- This function is used when input value vibrates or repeatedly shake by included noise at input signal. Accurate control is available by stable input with this function. It adopts moving average filter method not to affect sampling cycle. It is able to read/write by Configurator or Explicit message.
- It is applied when Moving Average is set as ON at Function Choice of Analog Input Point. Set the number of digital filters at Moving Average Filter of Number.
- Setting range: 0 to 8
(factory default: 3[Moving Average No_8])

○ Input min./max. value save

• Min./Max. save when power is ON

It saves min./max. input value from power ON the network. (When network power is OFF, the saved min./max. input value are cleared.)

It is able to read by Configurator or Explicit message. When Clear Max, Clear Min Flag bit of is ON at Function Choice of Analog Output Point Object, the saved values are cleared and it saves current min./max. value of current input.

• Min./Max. save when Peak/Bottom Hold signal is ON

It memorizes the max./min. value while Peak/Bottom signal is ON. When Peak/Bottom signal is OFF, they are saved.

It is able to read by Configurator or Explicit message. It is applied when Peak/Bottom is set as ON at Function Choice of Analog Input Point Object. You can check the value of Peak/Bottom at Peak Value and Bottom Value.

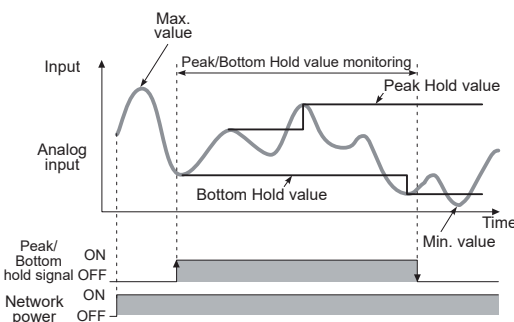

○ Disconnection detection

- When operating analog input cable (voltage/current input) is disconnected, Broken Wire Flag Bit turns ON at Analog Status Flag Read of Analog Input Point Object. (It operates only for 1-5V, 4-20mA input range.) It is able to read by Configurator or Explicit message.
- If this value is below -5%, it recognizes disconnection and displays '32767' as data value.

○ Input comparison

- It compares analog input value or the operation value and alarm set value (HH, H, L, LL) and Analog Status Bit flag turns ON at Function Choice of Analog Input Point Object. It is able to read by Configurator or Explicit message.
- If the value is within the setting range between 'H' and 'L', it is available to apply by turning ON Pass Signal Flag bit at Analog Status Flag Read of Analog Input Point Object and turning ON/OFF Comparator Flag bit at Function Choice.

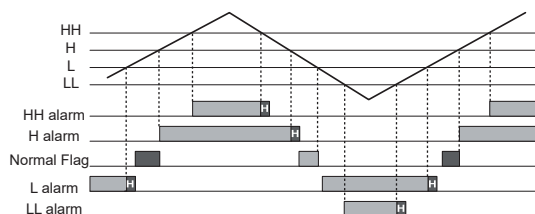

SENSORS
CONTROLLERS
MOTION DEVICES
SOFTWARE

(J) Temperature Controllers

(K) SSRs

(L) Power Controllers

(M) Counters

(N) Timers

(O) Digital Panel Meters

(P) Indicators

(Q) Converters

(R) Digital Display Units

(S) Sensor Controllers

(T) Switching Mode Power Supplies

(U) Recorders

(V) HMIs

(W) Panel PC

(X) Field Network Devices

○ Hysteresis

- In case of comparison output, this function is to increase stability of comparison output against vibration of input signal or chattering.
It is able to read by Configurator or Explicit message.
- It is applied when Compare Bit flag turns ON at Function Choice of Analog Input Point Object.
Set the value at Hysteresis Value.
- Setting range: 0 to 16,383 (factory default: 0)

○ Output value setting for com. error

- When communication error occurs, this function is to set output value of output unit by each channel. It is able to read by Configurator or Explicit message.
- Set Fault state at Fault Action of Analog Output Point.
- Setting range: 0 to 3 (factory default: 1)
 - 0: Hold Last State-maintains the last status
 - 2: High Limit-outputs max. value
 - 1: Low Limit-outputs min. value
 - 3: Zero Count-outputs 0%

○ Status flag monitoring

- When the network power voltage is lower than the set value or unit operation time is over the set value, monitoring is available by Status Bit of Application Object.
It is able to read by Configurator or Explicit message.
- ✕ Flag Bit
 - Bit 0: Reserved
 - Bit 1: Network Power Voltage Drops (below the set level)
 - Bit 2: Life State (Unit)
 - Bit 3: Reserved
 - Bit 4: Reserved
 - Bit 5: Reserved
 - Bit 6: Reserved
 - Bit 7: Reserved

○ Analog data allotment

- This function is to allot analog data. Select the desired data to transmit it to the master unit. It is able to read by Configurator or Explicit message.
- Set the allotment at Analog Data 1/2 Allocation selection of Analog Output Point.
- Setting range: 0 to 2 (factory default: 0)
 - 0: Analog Input Value
 - 1: Peak Value
 - 2: Bottom Value

■ Assembly Instance ID Assignment

○ Produced I/O assignment (Input)

It is available to assign I/O data by the selected data at master. When changing Produced I/O data assignment, re-supply the network power of ARD unit to apply the changed assignment.

1) Analog Data1 (Default I/O Data)

Analog Data 1 is assigned as Produced I/O data by Configurator or Explicit message. By property setting, assignment is available as Analog Input Value, Peak Value, Bottom Value.

- Assembly Instance ID: 103, • Default: 0
- Setting range: 0 to 2 (Analog Input Value: 0, Peak Value: 1, Bottom Value: 2)
- Data type: Word, Data size: 4Word

15	0	15	0
Assigned value to Analog Data 1 of Input point 0	Assigned value to Analog Data 1 of Input point 1	Assigned value to Analog Data 1 of Input point 2	Assigned value to Analog Data 1 of Input point 3

2) Analog Data2

Analog Data 2 is assigned as Produced I/O data by Configurator or Explicit message. By property setting, assignment is available as Analog Input Value, Peak Value, Bottom Value.

- Assembly Instance ID: 104, • Default: 0
- Setting range: 0 to 2 (Analog Input Value: 0, Peak Value: 1, Bottom Value: 2)
- Data type: Word, Data size: 4Word

15	0	15	0
Assigned value to Analog Data 2 of Input point 0	Assigned value to Analog Data 2 of Input point 1	Assigned value to Analog Data 2 of Input point 2	Assigned value to Analog Data 2 of Input point 3

3) Generic Status

Generic Status is assigned as Produced I/O data by Configurator or Explicit message.

- Assembly Instance ID: 100, • Data type: Byte, Data size: 1Byte
- Generic Status

Bit 0: Reserved.	Bit 3: Reserved.	Bit 6: Reserved.
Bit 1: Network Power Voltage Drops.	Bit 4: Reserved.	Bit 7: Reserved.
Bit 2: Life State (Unit)	Bit 5: Reserved.	

15	0
—	Generic Status

DeviceNet Analog Remote I/O

4) Analog Status

Analog Status is assigned as Produced I/O data by Configurator or Explicit message.

- Assembly Instance ID: 105
- Data type: Byte, Data size: 4Byte
- Analog Status

Bit 0: Low Alarm (LL) Bit 3: High Warning (H) Bit 6: Under Range
 Bit 1: Low Warning (L) Bit 4: High Alarm (HH) Bit 7: Over Range
 Bit 2: Pass Signal (Nomal) Bit 5: Broken Wire

15			0
	Analog Status of Input point 1		Analog Status of Input point 0
	Analog Status of Input point 3		Analog Status of Input point 2

5) Analog Data1+Analog Data2

Analog Data 1 + Analog Data 2 is assigned as Produced I/O data by Configurator or Explicit message. By property setting, assignment is available as Analog Input Value, Peak Value, Bottom Value.

- Assembly Instance ID: 106
- Default: 0
- Setting range: 0 to 2 (Analog Input Value: 0, Peak Value: 1, Bottom Value: 2)
- Data type: Word, Data size: 8Word

15		0 15		0
	Assigned value to Analog Data 1 of Input point 0		Assigned value to Analog Data 1 of Input point 2	
	Assigned value to Analog Data 2 of Input point 0		Assigned value to Analog Data 2 of Input point 2	
	Assigned value to Analog Data 1 of Input point 1		Assigned value to Analog Data 1 of Input point 3	
	Assigned value to Analog Data 2 of Input point 1		Assigned value to Analog Data 2 of Input point 3	

6) Analog Status+Generic Status

Analog Status + Generic Status is assigned as Produced I/O data by Configurator or Explicit message.

- Assembly Instance ID: 107
- Data type: Byte, Data size: 5Byte

15			0
	Analog Status of Input point 1		Analog Status of Input point 0
	Analog Status of Input point 3		Analog Status of Input point 2
	—		Generic Status

7) Analog Data+Analog Status

Analog Data 1 + Analog Status is assigned as Produced I/O data by Configurator or Explicit message. By property setting, assignment is available as Analog Input Value, Peak Value, Bottom Value.

- Assembly Instance ID: 108
- Default: 0
- Setting range: 0 to 2 (Analog Input Value: 0, Peak Value: 1, Bottom Value: 2)
- Data type: Byte, Data size: 12Byte

15				0
	Assigned value to Analog Data 1 of Input point 0			
	Assigned Low Byte at Analog Data 1 of Input point 1		Analog Status of Input point 0	
	Analog Status of Input point 1		Assigned High Byte at Analog Data 1 of Input point 1	
	Assigned value to Analog Data 1 of Input point 2			
	Assigned Low Byte at Analog Data 1 of Input point 3		Analog Status of Input point 2	
	Analog Status of Input point 3		Assigned High Byte at Analog Data 1 of Input point 3	

■ Cautions during Use

- Follow instructions in 'Cautions during Use'. Otherwise, it may cause unexpected accidents.
- 24VDC power supply should be insulated and limited voltage/current or Class 2, SELV power supply device.
- Keep away from high voltage lines or power lines to prevent inductive noise.
 In case installing power line and input signal line closely, use line filter or varistor at power line and shielded wire at input signal line.
 Do not use near the equipment which generates strong magnetic force or high frequency noise.
- This unit may be used in the following environments.
 - ①Indoors (in the environment condition rated in 'Specifications')
 - ②Altitude max. 2,000m
 - ③Pollution degree 2
 - ④Installation category II

SENSORS
CONTROLLERS
MOTION DEVICES
SOFTWARE
(J) Temperature Controllers
(K) SSRs
(L) Power Controllers
(M) Counters
(N) Timers
(O) Digital Panel Meters
(P) Indicators
(Q) Converters
(R) Digital Display Units
(S) Sensor Controllers
(T) Switching Mode Power Supplies
(U) Recorders
(V) HMIs
(W) Panel PC
(X) Field Network Devices