

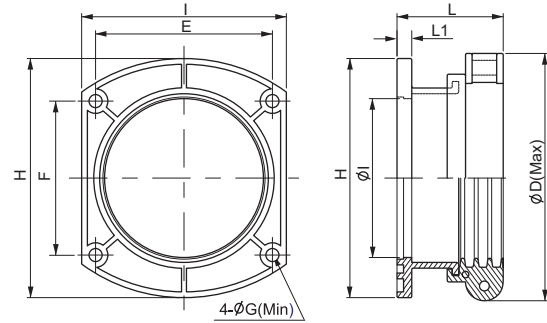





TNOC IP65



Black
 Gray

- Material: High Quality Polyamide6
- Protective: IP 65 (EN 60529)
- Temperature Range: -40° C to +105° C
- Short Term: up to +150° C
- Self-Extinguishing: UL94-HB
Free of Halogen Phosphorous and cadmium
- Color: Black & Gray
- Application: Machine tool, Shipbuilding, Tramway
Industrial / Automatic Machinery
Printing Machine etc.Control Box with connector

(dimensions in mm)

| Order No. | |  |  |  |  |  |  | | | | | |
|-----------|----------|---|--|---|---|---|---|----------------|------|----------------|----------------|----|
| Black | Gray | For tube size | E | F | G | H | I | L ₁ | L | Ø _i | Ø _D | SW |
| TNOC-56B | TNOC-56G | 56 | 67 | 61 | 7 | 96 | 81 | 4 | 39.2 | 56 | 93 | - |
| TNOC-70B | TNOC-70G | 70 | 84 | 78 | 7 | 113 | 98 | 9 | 52 | 70 | 121 | - |
| TNOC-95B | TNOC-95G | 95 | 108 | 94 | 8 | 146 | 125 | 9 | 64.7 | 92 | 151 | - |

