

Safety Cat. 4, Finger/Hand/Body Detection Safety Light Curtains

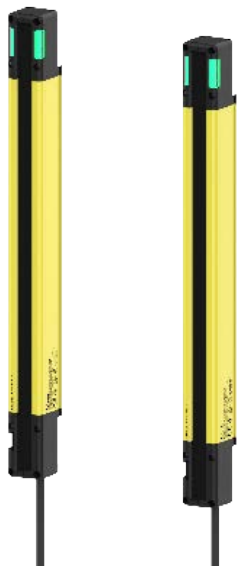

SFL / SFLA Series PRODUCT MANUAL

For your safety, read and follow the considerations written in the instruction manual, other manuals and Autonics website.

The specifications, dimensions, etc. are subject to change without notice for product improvement. Some models may be discontinued without notice.

Features

- International safety standard and regulation compliance
 - Type 4 ESPE (AOPD), SIL3, SIL CL3, Category 4, PL e, CE, UKCA, UL Listed, S-Mark, KCs (industrial robot protection device)
- Available in 3 detection type models (finger, hand, hand-body detection) and various protection height models
- Various safety-related functions & self-diagnosis functions
- Various status readings with 7-segment display and status indicators
- Easy beam adjustment with top and bottom beam indicators
- Upper OSSD indicator to check operation status and muting status (separate muting lamp not required)
- 4 non-safety outputs for various applications (2 AUX, 2 lamp)
- Stable operation in diverse conditions including low temperature, oil, high pressure water
 - Protection rating: IP65, IP67, IP67G, IP69K
 - Ambient temperature: -30 to 60 °C
- Additional functions and configuration available with dedicated software (atLightCurtain) (SFLA Series)

Safety Considerations

- Observe all 'Safety Considerations' for safe and proper operation to avoid hazards.
- ⚠ symbol indicates caution due to special circumstances in which hazards may occur.

⚠ Warning Failure to follow instructions may result in serious injury or death.

- Fail-safe device must be installed when using the unit with machinery that may cause serious injury or substantial economic loss.** (e.g. nuclear power control, medical equipment, ships, vehicles, railways, aircraft, combustion apparatus, safety equipment, crime/disaster prevention devices, etc.)
Failure to follow this instruction may result in personal injury, economic loss or fire.
- Do not use the unit in the place where flammable/explosive/corrosive gas, high humidity, direct sunlight, radiant heat, vibration, impact, or salinity may be present.**
Failure to follow this instruction may result in explosion or fire.
- Do not connect, repair, inspect, or replace the unit while connected to a power source.**
Failure to follow this instruction may cause malfunction or danger due to the safety-related function that does not operate properly. For more information, please refer to laws, regulations and standards in the country or region.
- Do not disassemble or modify the unit.**
Failure to follow this instruction may result in personal injury or fire. In addition, the manufacturer does not guarantee the performance and functionality.
- After 3 seconds of power input, use a machine or mechanical system.**
Failure to follow this instruction may cause malfunction or danger due to the safety-related function that does not operate properly.
- Responsible person for use is an operator who:**
 - is fully knowledgeable about the installation, settings, use and maintenance of the product.
 - is familiar with the requirements of laws, regulations and standards in the country or region where the product is installed and used.**Responsible person for use has an obligation to educate the requirements to machine users. Machine users are persons who have been fully trained by the responsible person for use and can operate the machine correctly. When any error occurs during the operation of the machine control system, they have a responsibility to report it to the responsible person for use immediately.**
If an unqualified person operates the product, it may result in personal injury, economic loss or fire.
- Qualified personnel shall carry out installation, configuration and combination with the machine control system.**
If an unqualified person carries out installation, configuration and combination with the machine control system, it may cause malfunction or result in accidents due to undetected human body.
- Make sure that only the responsible person uses the keys or tools for accessing and setting the light curtains.**
Failure to follow this instruction may cause malfunction or result in accidents.
- SFL□-□-□A models acquire KCs certification as an industrial robot protection device.**
Do not use it for any other purposes.
- When the machine is not operating after installation, check that functions and settings of the product operate correctly as you intended.**
Failure to follow this instruction may result in personal injury due to undetected human body.
- Always make sure that the safety distance between the light curtain and the hazardous part (hazardous zone or hazardous source) of the machine.**
The machine may not stop before an operator reaches the hazardous zone so that it may result in personal injury.
For more information on the safety distance, please refer to laws, regulations and standards in the country or region.
- To access the hazardous part (hazardous zone or hazardous source) of the machine, you shall install the light curtain as human body passes through the detection zone. If the hazardous part of the machine is accessible beyond the detection zone, install additional guards. In addition, when working in the hazardous zone, make sure that a part of human body is within the detection zone.**
If the installation does not detect the human body, it may result in personal injury.
- Do not arrange or use the light curtain as a reflective or retroreflective type with reflector.**
If the installation does not detect the human body, it may result in personal injury.
- Do not use the light curtain to detect flying objects toward the detection zone.**
If there is a risk, take additional safety measures, such as installing an additional safety guard.

15. **The auxiliary output (AUX) is non-safety output, therefore, do not use it for safety purposes.**
Failure to follow this instruction may result in serious injury because the safety cannot be guaranteed.
16. **The lamp output (Lamp) is non-safety output, therefore, do not use it for safety purposes.**
Failure to follow this instruction may result in serious injury because the safety cannot be guaranteed.
17. **Only qualified personnel shall use the PC setting tool (atLightCurtain) to configure functions of light curtain and manage the changed settings.**
If an unqualified person tries to change settings of function via the PC setting tool, it may cause malfunction or result in personal injury due to undetected human body.
18. **After setting or changing the function of light curtain via the PC setting tool, check that light curtain operates as you intended.**
Failure to follow this instruction may result in personal injury.
19. **When installation, if you have changed the configuration of light curtain (replacement of light curtain, change the number of beams, change the number of series connection, etc.), set the function of the light curtain via the PC setting tool again.**
Failure to follow this instruction may result in personal injury due to unintended settings.
20. **If the (master) receiver has been replaced, send the setting information of PC setting tool to the replaced receiver gain.**
Failure to follow this instruction may result in personal injury due to unintended settings.
21. **Install the devices for releasing Interlock condition (e.g. switch) in a location where the entire hazardous zone can be seen or the devices cannot be handled within the hazardous zone.**
22. **When restarting the machine in interlock condition, make sure that no operators are in the hazardous zone.**
Failure to follow this instruction may result in personal injury due to undetected human body.
23. **Follow the requirements described in this manual for the muting devices and installation method to use muting function.**
For more information, please refer to laws, regulations and standards in the country or region. Failure to follow these requirements, the functions and performance are not guaranteed. It may result in personal injury.
24. **Install the muting devices in a location that can be changed by only qualified and responsible person for use.**
Change the installation location under the supervision of responsible person for use.
25. **The muting function temporarily stops the safety related functions of light curtain.**
If the function is activated, take additional safety measures for the safety of the machine control system.
26. **When the muting function is activated, make sure that no operator is in the hazardous zone.**
Take additional safety measures to prevent the human body from entering the hazardous zone.
27. **When you need to inform that the muting function is activating, install the indicators with any forms (e.g. alarm lamp) where it can be seen from all sites.**
For more information, please refer to laws, regulations and standards in the country or region.
28. **Qualified and responsible person for use should conduct the risk assessment on the time related to the muting function, set the time correctly according to the conditions described in this manual. In particular, set the muting timeout (T2) to a finite value in the PC setting tool.**
Failure to follow this instruction may cause the function failure of safety related and result in personal injury or fire.
29. **When you use the auto scan for muting zone via PC setting tool, the OSSD output may temporarily go to ON state due to the operation of line or facilities for scan and measurement. Therefore, safety measures in workplace shall be implemented.**
If there is a risk, take additional safety measures, such as installing an additional safety guard.
30. **The installation environment and timing chart shown in the PC setting tool are examples for your understanding. Make sure that the qualified and responsible person for use check the light curtain operates in the actually installed site as intended.**
Failure to follow this instruction may result in personal injury due to undetected human body.
31. **Follow the requirements described in this manual for the devices and installation method to use the override function.**
For more information, please refer to laws, regulations and standards in the country or region. Failure to follow these requirements, the functions and performance are not guaranteed. It may result in personal injury.
32. **Connect the override switch to reset input to use the override function.**
Failure to release the override condition with the override switch may result in personal injury.
33. **The override function temporarily stops the safety related functions of light curtain. Therefore, safety measures in workplace shall be implemented.**
If the function is activated, take additional safety measures for the safety of the machine control system.
34. **When the override function is activated, make sure that no operator is in the hazardous zone.**
Take additional safety measures to prevent the human body from entering the hazardous zone.
35. **When you need to inform that the override function is activating, install the indicators with any forms (e.g. alarm lamp) where it can be seen from all sites.**
For more information, please refer to laws, regulations and standards in the country or region.
36. **Qualified and responsible person for use should conduct the risk assessment on the time related to the override function, set the time correctly according to the conditions described in this manual. In particular, set the override timeout to a finite value in the PC setting tool.**
Failure to follow this instruction may cause the function failure of safety related and result in personal injury or fire.
37. **After setting the fixed blanking function, check that it operates as intended.**
Failure to follow this instruction may result in personal injury due to undetected human body.
38. **If the tolerance is set for the fixed blanking function, the detection capability will be larger.**
Calculate the safety distance suitable for the minimum detection capability to secure minimum safety distance.
39. **If you use the fixed blanking function, conduct additional safety measures to prevent a part of human body from entering the hazardous zone passing by beams for the blanking zone.**
40. **After setting the floating blanking function, check that it operates as intended.**
Failure to follow this instruction may result in personal injury due to undetected human body.
41. **If the tolerance is set for the floating blanking function, the detection capability will be larger.**
Calculate the safety distance suitable for the minimum detection capability to secure minimum safety distance.
42. **If you use the floating blanking function, conduct additional safety measures to prevent a part of human body from entering the hazardous zone passing by beams for the blanking zone.**
43. **If you use the auto scan function for the fixed and floating blanking zone via the PC setting tool, the OSSD output temporarily goes to the OFF state.**
Please note that the operating status of the light curtain may be changed.
44. **If you use the reduced resolution function, the detection capability will be larger.**
Calculate the safety distance suitable for the minimum detection capability to secure minimum safety distance.
For the KCs certification models the use of this function is NOT guaranteed.
45. **Only qualified and responsible person for use shall use the factory reset via the PC setting tool. Also, check the safety distance and the operation of the light curtain again.**
Failure to follow this instruction may result in personal injury due to undetected human body.
46. **Check 'Connections' before wiring. And make sure that there are no safety problems.**
Failure to follow this instruction may result in fire.
47. **When using PNP output, be sure to connect the load between the OSSD output wire and 0V. Do not short the OSSD output wires to +24V.**
Incorrect wiring or shut down of the power supply is dangerous because the OSSD output is always in ON state.
48. **When using NPN output, be sure to connect the load between the OSSD output wire and +24V. Do not short the OSSD output wires to 0V.**
Incorrect wiring or shut down of the power supply is dangerous because the OSSD output is always in ON state.
49. **Use only the two OSSD output wires in this product to construct safety systems, and do not use output signals (e.g. auxiliary output) other than the OSSD output for safety purposes.**
When you use only one OSSD output or use other output signal as a safety output, the machine cannot be stopped in the event of a malfunction and result in personal injury due to the safety related function failure.
50. **When wiring, all input/output wires with double insulation or reinforced insulation should be used between the circuits.**
Failure to follow this instruction may result in fire.
51. **Do not install all input/output wires in the same piping with high voltage wire and power line.**
Failure to follow this instruction may cause malfunction or dangerous due to the safety related function do not operate properly.
52. **Use a separate power supply for the load and the product, and do not exceed the specified ratings.**
Failure to follow this instruction may result in damage or malfunction of the product.

Caution Failure to follow instructions may result in injury or product damage.

01. **Use the product within the rated specifications.**
Failure to follow this instruction may result in fire or product damage.
02. **Use a dry cloth to clean the unit, and do not use water or organic solvent.**
Failure to follow this instruction may result in fire.
03. **The total length of extended cables for power supply should be within 30 m. Do not modify, change the cables.**
If the cable is longer than the specification, it may cause malfunction or dangerous due to the safety related function do not operate properly.
04. **To use the light curtain in "PSDI mode", configure the appropriate control circuit between the light curtain and the machine according to the requirements of laws, regulations and standards in the country or region.**
05. **Do not use the product outdoors.**
Failure to follow this instruction may result in damage and malfunction of the product.
06. **Keep the product away from metal chip, dust, and wire residue which flow into the unit.**
Failure to follow this instruction may result in personal injury due to the malfunction of the light curtain.
07. **Be sure for responsible person for use to change the password of PC setting tool to prevent the setting change by the machine users (or operator). Securely manage your password and avoid forgetting the password.**
Failure to follow this instruction may result in personal injury due to the malfunction of the light curtain.
08. **You must conduct regular inspections and maintenance procedures according to the items listed on the "Check and Maintenance" within six months.**
Failure to follow this instruction may result in personal injury due to the malfunction of the light curtain.
09. **Check the installation status, normal operation, breakage, modification, and manipulation in the situations shown below, and conduct the weekly inspection.**
 - When starting the safety system for the first time
 - When replacing the accessories of the safety system
 - When the safety system has not been operated for a long time

Cautions for Installation

- For more information, refer to the "SFL/SFLA User Manual."
- Install the unit correctly with the usage environment, location, and the designated specifications. Install the light curtain that complies with the following details.
 - Part(s) of the human body passes through the detection zone to the hazards of the machine.
 - Install an additional guard if part(s) of the human body access to hazards of the machine without passing through the detection zone.
 - If an operator works in the hazardous part of the machine, be sure to install the light curtain to detect part(s) of the human body.
 - You must set the safety distance of the light curtain.
Failure to this instruction, the machine cannot be stopped before reaching the hazardous part, and it may result in personal injury.
The safety distance calculation may differ from laws, regulations, and standards. Therefore, be sure to use the appropriate formula which abides by the rules of the country.
 - Install the emitter and the receiver face to each other and adjust the top and bottom beam of the light curtain to meet the centerline. Also, the switch settings of the emitter and the receiver must be the same.
 - Be sure to apply the power to both the emitter and the receiver at the same time.
If not, the product enters the lockout condition, and the red and green LED of the upper OSSD indicators flash alternately.
 - Use a bracket suitable for the mounting method.
The type and number of brackets differ depending on the length of the light curtain.

Cautions during Use

- Follow instructions in "Cautions during Use". Otherwise, it may cause unexpected accidents.
- The power input of 24VDC≒ model is insulated and limited voltage/current or supply via power supply with SELV and Class 2.
- When supplying power with SMPS, ground the F.G. terminal and connect the noise suppression capacitor between 0V and F.G. terminal.
- Be sure to use separate F.G. between the product and equipment with a strong noise (welding machine). The same F.G. may result in malfunction.
- When installing the product, connect the emitter and receiver with having the same version. Failure to follow this instruction may cause malfunction or dangerous due to the safety related function do not operate properly.
- When installing the light curtain, make sure that the bottom indicators of the emitter and receiver are aligned exactly.
- Install the light curtain in a place where the emitter and receiver are not affected by walls or reflecting surfaces.
- If you use the light curtain as several sets, arrange them not to interfere with each other, or install with a shading plate.
- Do not install the light curtain in place where it is exposed to intense disturbance light (such as direct sunlight, sunlight, spotlights fluorescent lights, and etc.) or reflected light from glossy surface is directly incident on the receiver. If it is difficult to install in such a place, take additional safety measures using shading plates, hoods, etc. Failure to follow this instruction may cause malfunction or dangerous due to the safety related function do not operate properly.
- Make sure that any unused wires, when installing the product, should be insulated.
- Make sure that removable parts (including packing, end caps, product wires, covers, etc.) are properly assembled. Also, tighten the screws with specified tightening torque. Failure to follow this instruction may cause product degradation.
- Assessment of conformity to the required safety level is evaluated for the entire system. Please consult with a certified certification body regarding the assessment procedure.
- It should be done away regarded as an industrial waste. For more information, please refer to laws, regulations and standards in the country or region.
- This product may be used in the following environments.
 - Altitude max. 2000 m
 - Pollution degree 3
 - Installation Category II

Ordering Information

This is only for reference, the actual product does not support all combinations. For selecting the specified model, follow the Autonics website.

SFL ① ② - ③ - ④

① Type

No-mark: Standard type
A: Advanced type

② Detection capability

14: Ø 14 mm, finger
20: Ø 20 mm, hand
30: Ø 30 mm, hand-body

③ Number of optical axes

Number: Number of optical axes

④ Korea safety certification

No-mark: S-mark
A: KCs (industrial robot protection device)

Product Components

- Product
- Instruction manual

Manual

For proper use of the product, refer to the manuals and be sure to follow the safety considerations in the manuals. Download the manuals from the Autonics website.

Dimensions

- Unit: mm. For the detailed drawings, follow the Autonics website.
- This dimension is based on the SFL(A) 14 model. The appearance varies depending on the detection capability.

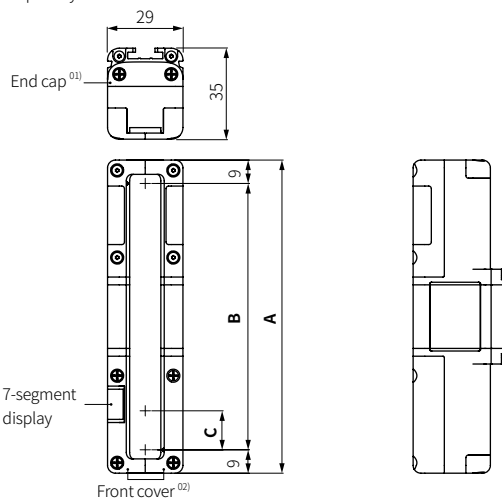

- 01) When removing the end cap, there is the lamp output terminal (top) or the power supply terminal (bottom).
02) When removing the front cover, there is the setting switch (on the emitter and the receiver) or the PC communication port (on the receiver).

Detection capability	Models	Number of beams	A (protective height)	B (sensing height)	C (optical axis pitch)
Ø 14 mm (finger)	Standard	15 to 111	144 to 1,008	126 to 990	9
	Advanced	15 to 199	144 to 1,800	126 to 1,782	
Ø 20 mm (hand)	Standard	12 to 68	183 to 1,023	165 to 1,005	15
	Advanced	12 to 124	183 to 1,863	165 to 1,845	
Ø 30 mm (hand-body)	Standard	42 to 75	1,043 to 1,868	1,025 to 1,850	25
	Advanced	9 to 75	218 to 1,868	200 to 1,850	

Sold Separately

- Power I / O cable : SFL-BCT(R), SFL-C□T(R)
- M12 connector cable : CID8-□T(R), C1D8-□T(R)
- Y type connector cable: SFL-YC, SFL-YCR
- Series connector cable: SFL-EC□T(R)
- Lamp output cable: SFL-LC
- Bracket: BK-SFL-□□
- SFL / SFLA dedicated USB to Serial communication converter: SCM-SFL
- Test piece: SFL-T□

Specifications

Type	Standard type		
Models	SFL14-□-□	SFL20-□-□	SFL30-□-□
Sensing type	Through-beam		
Light source	Infrared LED (855 nm)		
Effective aperture angle (EAA)	Within ± 2.5° when the sensing distance is greater than 3 m for both emitter and receiver.		
Sensing distance	Short - Long mode (setting switch)		
Short mode	0.2 to 5 m	0.2 to 8 m	0.2 to 8 m
Long mode	0.2 to 10 m	0.2 to 15 m	0.2 to 15 m
Detection capability	Ø 14 mm (finger)	Ø 20 mm (hand)	Ø 30 mm (hand-body)
Detection object	Opaque object		
Number of optical axes ⁰¹⁾	15 to 111	12 to 68	42 to 75
Protective height	144 to 1,008 mm	183 to 1,023 mm	1,043 to 1,868 mm
Optical axis pitch	9 mm	15 mm	25 mm
Series connection	Max. 3 SET (≤ 300 optical axes)		

Type	Advanced type		
Models	SFLA14-□-□	SFLA20-□-□	SFLA30-□-□
Sensing type	Through-beam		
Light source	Infrared LED (855 nm)		
Effective aperture angle (EAA)	Within ± 2.5° when the sensing distance is greater than 3 m for both emitter and receiver.		
Sensing distance	Short - Long mode (setting switch or atLightCurtain)		
Short mode	0.2 to 5 m	0.2 to 8 m	0.2 to 8 m
Long mode	0.2 to 10 m	0.2 to 15 m	0.2 to 15 m
Detection capability	Ø 14 mm (finger)	Ø 20 mm (hand)	Ø 30 mm (hand-body)
Detection object	Opaque object		
Number of optical axes ⁰¹⁾	15 to 199	12 to 124	9 to 75
Protective height	144 to 1,800 mm	183 to 1,863 mm	218 to 1,868 mm
Optical axis pitch	9 mm	15 mm	25 mm
Series connection	Max. 4 SET (≤ 400 optical axes)		

01) It may differ depending on the models. For more information, refer to the "SFL/SFLA User Manual."

Power supply	24 VDC ≒ ± 20% (Ripple P-P: ≤ 10%)
Current consumption ⁰¹⁾	Emitter: ≤ 106 mA, receiver: ≤ 181 mA
Response time ⁰¹⁾	T _{OFF} (ON → OFF): ≤ 19.9 ms, T _{ON} (OFF → ON): ≤ 49.7 ms
Safety related output : OSSD output	NPN or PNP open collector Load voltage ⁰²⁾ : ON - 24 VDC≒ (except for the residual voltage), OFF - 0 VDC≒, Load current ⁰³⁾ : ≤ 300 mA, Residual voltage ⁰⁴⁾ : ≤ 2 VDC≒ (except for voltage drop due to wiring), Load capability: ≤ 2.2 µF, Leakage current: ≤ 2.0 mA, Wire resistance of load: ≤ 2.7 Ω
Auxiliary output (AUX 1/2) ⁰⁵⁾	NPN or PNP open collector Load voltage: ≤ 24 VDC≒, Load current: ≤ 100 mA, Residual voltage: ≤ 2 VDC≒ (except for voltage drop due to wiring)
Lamp output (LAMP 1/2) ⁰⁶⁾	NPN or PNP open collector Load voltage: ≤ 24 VDC≒, Load current: ≤ 300 mA Reset input, mute 1/2 input, EDM, external test
External input	When setting NPN output ON: 0 - 3 VDC≒, OFF: 9 - 24 VDC≒ or open, short-circuit current: ≤ 3 mA When setting PNP output ON: 9 - 24 VDC≒, OFF: 0 - 3 VDC≒ or open, short-circuit current: ≤ 3 mA
Protection circuit	Reverse power polarity, reverse output polarity, output short-circuit over-current protection
Safety-related functions	Interlock (reset hold), external device monitoring (EDM), muting/override, Blanking (fixed blanking, floating blanking), reduced resolution
General functions	Self-test, alarm for reduction of incident light level, mutual interference prevention
Others functions	Change of sensing distance, switching to NPN or PNP, external test (light emission stops), auxiliary output (AUX 1, 2), lamp output (LAMP 1, 2)
Synchronization type	Timing method by RS485 synchronous line
Insulation resistance	≥ 20MΩ (at 500 VDC≒ megger)
Noise immunity	± 240 VDC≒ the square wave noise (pulse width: 1µs) by the noise simulation
Dielectric strength	1,000 VAC ~ 50 / 60 Hz for 1 minute
Vibration ⁰⁶⁾	10 mm double amplitude at frequency of 5 to 150 Hz, 10 sweeps in each X, Y, Z direction
Shock ⁰⁶⁾	250 m/s ² (≈ 25 G), pulse width 6 ms in each X, Y, Z direction for 100 times
Ambient illumination (receiver)	Incandescent lamp: ≤ 3,000 lx, sunlight: ≤ 10,000 lx
Ambient temperature	-30 to 60 °C, storage: -30 to 70 °C (no freezing or condensation)
Ambient humidity	35 to 85 %RH, storage: 35 to 95 %RH (no freezing or condensation)
Protection rating ⁰⁷⁾	IP65, IP67 (IEC standard), IP67G (JEM Standard), IP69K (DIN standard)
Material	Case: Aluminum, Front cover and sensing part: Polymethyl methacrylate, End cap: polycarbonate, Power I/O cable and connector cable: polyurethane (PUR) or polyvinyl chloride (PVC), Y type connector cable: polyvinyl chloride (PVC), lamp output cable and series connector cable: polyurethane (PUR), Top / Bottom adjustable bracket and Top / Bottom bracket: SUS304, Side adjustable bracket and Side bracket: nickel plated Zn
Approval	CE, TÜV NORD, (industrial robot protection device) ⁰⁸⁾
International standards	UL 508, CSA C22.2 No. 14, ISO 13849-1 (PL e, Cat. 4), ISO 13849-2 (PL e, Cat. 4), UL 61496-1 (Type 4, ESPE), UL 61496-2 (Type 4, AOPDs), IEC/EN 61496-1 (Type 4, ESPE), IEC/EN 61496-2 (Type 4, AOPDs), IEC/EN 61508-1~7 (SIL 3), IEC/EN 62061 (SIL CL 3)

01) It may differ depending on the models. For more information, refer to the "SFL/SFLA User Manual."

02) The values of load output were drawn with PNP output, and in case of NPN output, apply these in reverse.

03) Be sure that the load current should be greater than 6 mA.

04) The residual voltage was drawn with 300 mA of load current.

05) It is the non-safety output. Do not use it for safety purposes.

06) Testing according to IEC 61496-1 standards.

07) Approved certification protection ratings are IP65 and IP67.

08) The certified models for S-mark and KCs (industrial robot protection device) have the same functional basis.

Setting Switch

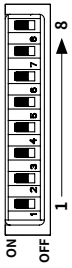

No.	Function	Settings (marks in the sticker)	
		ON	OFF (factory default)
1	NPN or PNP	NPN	PNP
2	Sensing distance	Short mode (S)	Long mode (L)
3	Frequency	Frequency B (FREQ B)	Frequency A (FREQ A)
4	Reset-hold	Reset-hold (R-H)	Deactivated (OFF)
5	Interlock	Manual reset (MAN)	Auto reset (AUTO)
6	EDM	EDM	Deactivated (OFF)
7	Muting	MUTE	Deactivated (OFF)
8	Apply settings	atLightCurtain (PC)	Setting switch (SW)

- Remove the front cover of the light curtain and set functions via the setting switch.
- Be sure to select the same settings of emitter and receiver. (factory defaults: OFF)
- For more information, refer to the "SFL/SFLA User Manual."

7-segment Display

Operation	Position	Display	Description
Emitter/Receiver	PC connection (download)	P	Flashing Flashes when downloading the setting information.
	Communication error	ε	Flashing Flashes when RS485 communication error occurs.
	Error condition	E	Flashing Flashes when entering the lockout condition.
Emitter	Warning condition	W	Flashing Flashes when in a warning condition.
	Default condition	0	ON Displays when function is deactivated.
	Blanking	b	ON Displays when the blanking function is activated.
	Muting	ā	ON Displays when in the muting state.
	Override	o	ON Displays when in the override state.
	Reset-hold	H	ON Displays when waiting for reset-hold input.
	Reduced resolution	r	ON Displays when the reduced resolution function is activated.
Receiver	Light incident	0 to 9	ON Displays the sensitivity level of beams with the lowest light incident (0 to 9).

- This table shows the display during operation.
- For more information on the display of power on and error condition, refer to the "SFL/SFLA User Manual."

Brackets Installation

Top/Bottom adjustable bracket (BK-SFL-TBA)

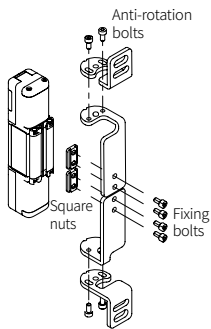

Top/Bottom bracket (BK-SFL-TBF)

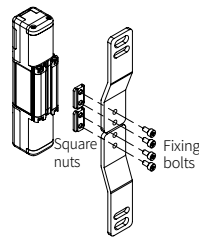

Side adjustable bracket (BK-SFL-SA)

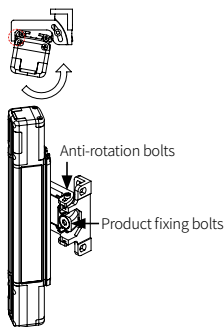

Side bracket (BK-SFL-SF)

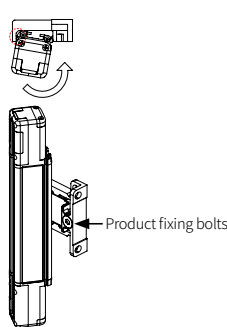

- Tighten the product fixing bolts with a torque of 0.98 N·m.
- The type and number of brackets differ depending on the length of the light curtain.

Brackets	Length	Max. 1 m	Min. 1 m
Top/Bottom adjustable bracket		2	Unavailable
Top/Bottom bracket			3
Side adjustable bracket		2	3
Side bracket			3

- For more information, refer to the "SFL/SFLA User Manual."

Example of Wiring Diagram

The wiring varies depending on the functions you use. For more information, refer to the "SFL/SFLA User Manual." If there is a potential malfunction due to noise, combine a protection circuit to the input wiring, or connect a device with a protection circuit and apply the signal.

NPN output

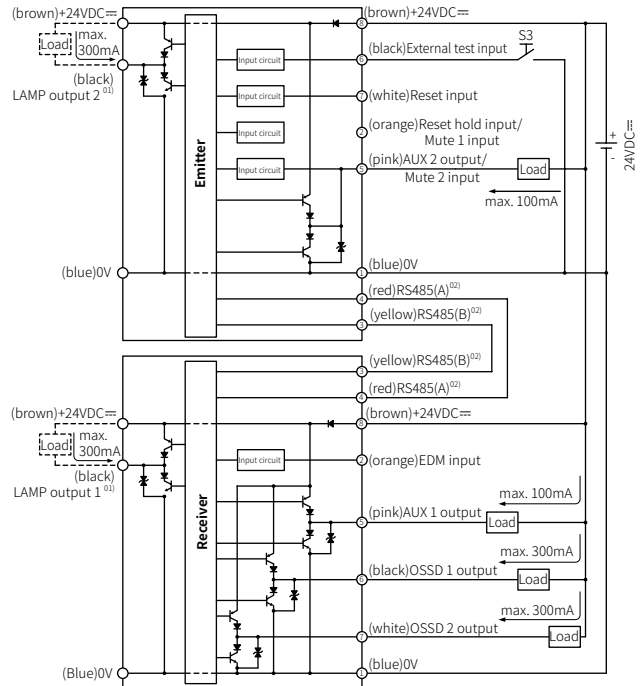

PNP output

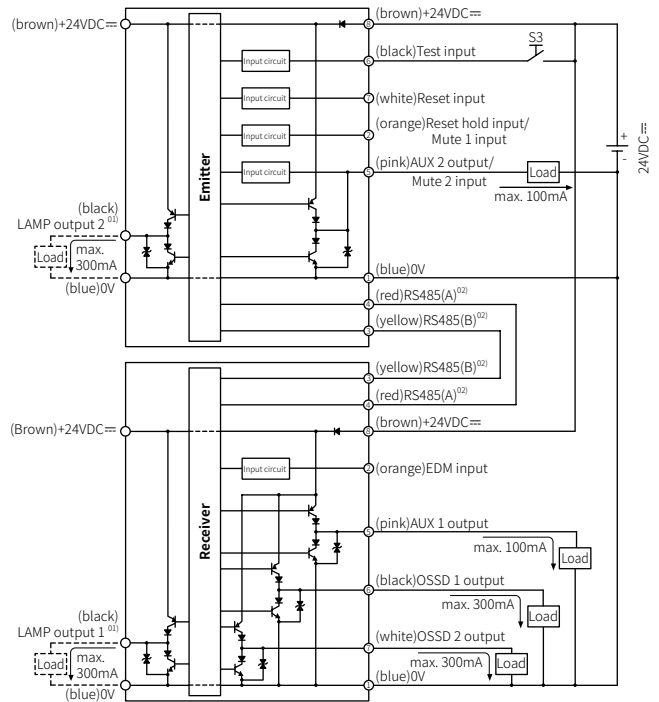

- This wiring is used to activate the lamp output and displays the status to the external indicator based on selected output mode.
- RS485(A) and RS485(B) are for the synchronous line.

Software

Download the installation file and the manuals from the Autonics website.

atLightCurtain

It is a software that provides configuration and monitoring functions of safety light curtain as well as detailed information such as product version. In case of SFL (Standard type), only monitoring function is supported, and in case of SFLA (advanced type), all functions such as parameter setting are available.

Check and Maintenance

You must conduct regular inspections within six months, according to the items listed on the checklist. Or it may result in personal injury due to the malfunction of the light curtain. The checklist before the installation is the table below. For the checklist after the installation, refer to the "SFL/SFLA User Manual."

■ Check installation conditions

No.	Checklist	Check
1	Installed that the machine or additional safety measures (e.g., extra guards) do not cover the detection zone.	
2	Accessible to hazardous zone or source of the machine only by passing through the detection zone.	
3	Available to detect parts of the body when the operator works in hazardous zone or source of the machine.	
4	The distance from hazardous zone or source of the machine to the installed location of light curtain is equal to, or greater than the calculated safety distance. ※Safety distance: ()mm / Actual distance: ()mm	
5	If lustered objects or reflective surfaces are around, the light curtain is installed at a distance over the allowable installation distance.	
6	Installed in a place without the influence of inverter disturbance light (e.g., a fluorescent lamp).	
7	Installed in a place that no material causes deformation in a front window, such as corrosion or ignition.	
8	In use of the interlock function, the reset switch is installed in a position where the entire hazardous zone is visible and cannot be used in the hazardous zone.	
9	In use of the reset hold function, the reset hold switch is installed in a position that cannot be used in the hazardous zone.	
10	The installed emitter/receiver in a single or series connection matches the same specification (function, detection capability, number of optical axes).	
11	In case of the brackets, it is secured to prevent separation during use.	
12	No scratches or damages on the front window of the emitter/receiver.	
13	In use of the muting function, the muting sensors consist of two separate devices.	
14	In use of the muting function, the muting sensor meets the specific conditions to start muting.	
15	In use of the override function, the override starts when the specific conditions are met.	
16	In use of the muting and override functions, install the indicators with any forms (e.g., alarm lamp) where it can be seen from all sites.	
17	In use of the fixed blanking function, it is set to prevent the operator from entering the blanking zone.	
18	In use of the floating blanking or reduced resolution function, the installed light curtain has a distance that equal to or greater than a safety distance calculated by the changed detection capability (diameter). ※Safety distance: ()mm / Actual distance: ()mm	

■ Check wiring connection

No.	Checklist	Check
1	The power supply used for the product and safety-related devices (e.g., muting sensors) is 24VDC=, and it meets the rated specifications and not connected to other devices or equipment.	
2	When connecting power supply, the polarity is not connected in reverse.	
3	The appearance of the wires connected to the product is not damaged, such as cracks, breakage of the outer shell. And there are no sources for damage around the wiring.	
4	In case of connecting more than two products, it is configured to use dedicated series connection cable and mutual interference prevention.	
5	In case of the series connection for more than two products, use dedicated series connection cable, and it is configured not to be extended or arbitrarily connected.	
6	The wiring is suitable for each application and is configured not to be connected upper side of the product (e.g., wiring for the series connection cable and lamp output cable) and the lower side of the product (e.g., the power I/O cable) in reverse.	
7	The wiring and end cap connected to the product are firmly secured to prevent separation during use.	
8	The product is connected to the safety-related part of the control system using two OSSD control outputs and configures the safety system.	
9	In case of the product is set to PNP output, two OSSD wires are not shorted to +24V.	
10	In case of the product is set to PNP output, the load connected to two OSSD wires is connected between the OSSD wire and 0V.	
11	In case of the product is set to NPN output, two OSSD wires are not shorted to 0V.	
12	In case of the product is set to NPN output, the load connected to two OSSD wires is connected between the OSSD wire and +24V.	
13	In case of the auxiliary output (AUX 1/2, Lamp 1/2), it is configured to prevent the connection to the safety-related part of the control system.	
14	The power I/O cable is connected with its direction of protrusion towards the outside.	

Product Version Classification

Product connection is not possible if the emitter / receiver versions are different. Series connection function is available only when all connected SETs have the same product version. Ensure that the devices are the same version through the front part or side stickers. Check the product version at the dedicated software (atLightCurtain). For more information, refer to the "SFL/SFLA User Manual."

Unit Descriptions

The appearance may vary depending on the detection capability. For more information, refer to the "SFL/SFLA User Manual."

■ Front part

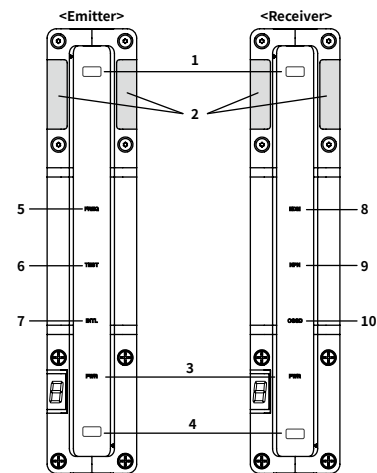

Position	Indicator	Color	Operation	Description
Emitter/ Receiver	1. Top beam indicator	Blue	ON	Top beam is clear (≥ incident light level 30%)
			Flashing	Top beam is unstable (incident light level: 15 to 35% ⁽⁰¹⁾)
			OFF	Top beam is blocked (≤ incident light level 15%)
	2. Upper OSSD indicator	Green	ON	OSSD is ON
			Flashing	Muting or override function is activated.
	3. Power/Lockout indicator	Red	ON	OSSD is OFF
			Flashing	Enter lockout condition
			OFF	Normal operation
	4. Bottom beam indicator	Blue	ON	Bottom beam is clear (≥ incident light level 30%)
			Flashing	Bottom beam is unstable (incident light level: 15 to 35% ⁽⁰¹⁾)
OFF			Bottom beam is blocked (≤ incident light level 15%)	
Emitter	5. Frequency indicator	Green	ON	Set frequency B
			OFF	Set frequency A
	6. External test indicator	Green	ON	External test input is ON state.
			OFF	External test input is OFF state.
	7. Interlock indicator	Yellow	ON	Interlock condition
			Flashing	Reset-hold condition
			OFF	Release interlock condition
Receiver	8. EDM indicator	Green	ON	EDM input is ON state.
			Flashing	EDM error ⁽⁰²⁾
	9. NPN/PNP indicator	Green	ON	EDM input is OFF state or EDM is deactivated.
OFF			PNP output	
OSSD indicator	Green	ON	NPN output	
		Red	OSSD is OFF	

(01) It flashes if the amount of received light on the top or bottom beam decreases less than from 15 to 35%, and lasts for more than 30 minutes.

(02) The light curtain enters the lockout condition. For more information on error and warnings, refer to the "SFL/SFLA User Manual."

■ Front part - When removing the cover

Tighten the cover screws on the front part with a torque of 0.59 N m.

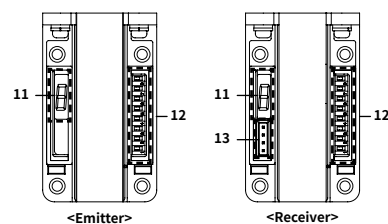

Position	Part	Description
Emitter/ Receiver	11. 7-segment display	It shows the status of light curtain.
	12. Setting switch	You can set the function.
Receiver	13. PC communication port	Insert the SFL / SFLA dedicated USB to Serial communication converter (SCM-SFL, sold separately).

■ Upper part

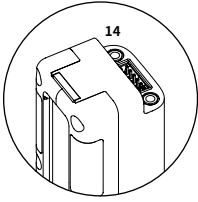

Position	Part	Description
Emitter/ Receiver	14. Lamp output terminal	It is located on the top of the emitter and receiver. Insert the lamp output cable and connect the external output indicator. Tighten the end cap screws with a torque of 0.59 N m. In case of the series connection, use dedicated series connection cable to connect light curtains.

■ Bottom part

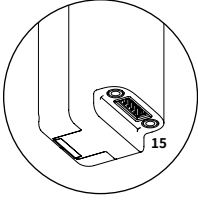

Position	Part	Description
Emitter/ Receiver	15. Power supply terminal	It is located on the bottom of the emitter and receiver. Insert the power I/O cable for power supply. Tighten the end cap screws with a torque of 0.59 N m. In case of the series connection, use dedicated series connection cable to connect light curtains.

IEC 61508 Parameters

Parameters	Explanation
Proof test interval	20 years
PFH ₀ (Probability of dangerous failure per hour)	$9.95 \times 10^{-9} \sim 1.01 \times 10^{-8}$
SFF (Safe failure fraction)	99 %
HFT (Hardware fault tolerance)	1
Type of element	Type B
Failure response time	Within a response time
Safe state	OSSD 1/2 are in OFF-state

■ Finger detection (SFL(A)14-□-□, Ø 14 mm)

- SFL□-□-□-□-□-□-□-□ models acquire KCs certification as an industrial robot protection device.

SFL Series	SFLA Series	PFH ₀	MTTFd (years)
SFL14-15-□	SFLA14-15-□	2.87×10^{-9}	455
SFL14-23-□	SFLA14-23-□	3.86×10^{-9}	327
SFL14-31-□	SFLA14-31-□	4.40×10^{-9}	283
SFL14-39-□	SFLA14-39-□	5.07×10^{-9}	242
SFL14-47-□	SFLA14-47-□	5.62×10^{-9}	217
SFL14-55-□	SFLA14-55-□	6.29×10^{-9}	192
SFL14-63-□	SFLA14-63-□	6.84×10^{-9}	176
SFL14-71-□	SFLA14-71-□	7.51×10^{-9}	160
SFL14-79-□	SFLA14-79-□	8.06×10^{-9}	148
SFL14-87-□	SFLA14-87-□	8.73×10^{-9}	136
SFL14-95-□	SFLA14-95-□	9.28×10^{-9}	128
SFL14-103-□	SFLA14-103-□	9.95×10^{-9}	119
SFL14-111-□	SFLA14-111-□	1.05×10^{-8}	113
	SFLA14-119-□	1.12×10^{-8}	106
	SFLA14-127-□	1.17×10^{-8}	101
	SFLA14-135-□	1.24×10^{-8}	95
	SFLA14-143-□	1.29×10^{-8}	91
	SFLA14-151-□	1.36×10^{-8}	86
	SFLA14-159-□	1.42×10^{-8}	83
	SFLA14-167-□	1.48×10^{-8}	79
	SFLA14-175-□	1.54×10^{-8}	76
	SFLA14-183-□	1.60×10^{-8}	73
	SFLA14-191-□	1.66×10^{-8}	70
	SFLA14-199-□	1.73×10^{-8}	68

■ Hand detection (SFL(A)20-□-□, Ø 20 mm)

- SFL□-□-□-□-□ models acquire KCs certification as an industrial robot protection device.

SFL Series	SFLA Series	PFH ₀	MTTFd (years)
SFL20-12-□	SFLA20-12-□	3.23×10^{-9}	398
SFL20-16-□	SFLA20-16-□	3.55×10^{-9}	358
SFL20-20-□	SFLA20-20-□	4.00×10^{-9}	314
SFL20-24-□	SFLA20-24-□	4.31×10^{-9}	289
SFL20-28-□	SFLA20-28-□	4.76×10^{-9}	260
SFL20-32-□	SFLA20-32-□	5.08×10^{-9}	242
SFL20-36-□	SFLA20-36-□	5.53×10^{-9}	221
SFL20-40-□	SFLA20-40-□	5.85×10^{-9}	208
SFL20-44-□	SFLA20-44-□	6.29×10^{-9}	193
SFL20-48-□	SFLA20-48-□	6.61×10^{-9}	183
SFL20-52-□	SFLA20-52-□	7.06×10^{-9}	171
SFL20-56-□	SFLA20-56-□	7.38×10^{-9}	163
SFL20-60-□	SFLA20-60-□	7.82×10^{-9}	153
SFL20-64-□	SFLA20-64-□	8.14×10^{-9}	147
SFL20-68-□	SFLA20-68-□	8.59×10^{-9}	139
	SFLA20-72-□	8.91×10^{-9}	134
	SFLA20-76-□	9.35×10^{-9}	127
	SFLA20-80-□	9.67×10^{-9}	123
	SFLA20-84-□	1.01×10^{-8}	117
	SFLA20-88-□	1.04×10^{-8}	113
	SFLA20-92-□	1.09×10^{-8}	109
	SFLA20-96-□	1.12×10^{-8}	105
	SFLA20-100-□	1.16×10^{-8}	101
	SFLA20-104-□	1.20×10^{-8}	98
	SFLA20-108-□	1.24×10^{-8}	95
	SFLA20-112-□	1.27×10^{-8}	92
	SFLA20-116-□	1.32×10^{-8}	89
	SFLA20-120-□	1.35×10^{-8}	87
	SFLA20-124-□	1.39×10^{-8}	84

■ Hand-Body detection (SFL(A)30-□-□, Ø 30 mm)

- SFL□-□-□-□-□ models acquire KCs certification as an industrial robot protection device.

SFL Series	SFLA Series	PFH ₀	MTTFd (years)
	SFLA30-9-□	3.06×10^{-9}	423
	SFLA30-12-□	3.32×10^{-9}	386
	SFLA30-15-□	3.71×10^{-9}	341
	SFLA30-18-□	3.97×10^{-9}	316
	SFLA30-21-□	4.36×10^{-9}	285
	SFLA30-24-□	4.63×10^{-9}	268
	SFLA30-27-□	5.02×10^{-9}	245
	SFLA30-30-□	5.28×10^{-9}	232
	SFLA30-33-□	5.67×10^{-9}	215
	SFLA30-36-□	5.93×10^{-9}	205
	SFLA30-39-□	6.32×10^{-9}	192
SFL30-42-□	SFLA30-42-□	6.58×10^{-9}	184
SFL30-45-□	SFLA30-45-□	6.97×10^{-9}	173
SFL30-48-□	SFLA30-48-□	7.23×10^{-9}	166
SFL30-51-□	SFLA30-51-□	7.62×10^{-9}	157
SFL30-54-□	SFLA30-54-□	7.88×10^{-9}	152
SFL30-57-□	SFLA30-57-□	8.27×10^{-9}	144
SFL30-60-□	SFLA30-60-□	8.54×10^{-9}	140
SFL30-63-□	SFLA30-63-□	8.93×10^{-9}	133
SFL30-66-□	SFLA30-66-□	9.19×10^{-9}	129
SFL30-69-□	SFLA30-69-□	9.58×10^{-9}	124
SFL30-72-□	SFLA30-72-□	9.84×10^{-9}	120
SFL30-75-□	SFLA30-75-□	1.02×10^{-8}	116

Response Time / Current Consumption

Response time is based on when the switch is factory settings. The time may differ if the setting is changed.

- TOFF (ON → OFF): Time when OSSD output is switched from ON to OFF state
 - TON (OFF → ON): Time when OSSD output is switched from OFF to ON state
- To calculate the response time in series connection, refer to the "SFL/SFLA User Manual."
- SFL□-□-A models acquire KCs certification as an industrial robot protection device.

■ Finger detection (SFL(A)14-□-□, Ø 14 mm)

SFL Series	SFLA Series	Response time (ms)		Current consumption (mA)	
		T _{OFF}	T _{ON}	Emitter	Receiver
SFL14-15-□	SFLA14-15-□	7.1 ms	15.5 ms	69 mA	94 mA
SFL14-23-□	SFLA14-23-□	7.8 ms	16.9 ms	71 mA	97 mA
SFL14-31-□	SFLA14-31-□	8.2 ms	18.1 ms	72 mA	101 mA
SFL14-39-□	SFLA14-39-□	8.7 ms	19.3 ms	74 mA	105 mA
SFL14-47-□	SFLA14-47-□	9.2 ms	20.5 ms	76 mA	109 mA
SFL14-55-□	SFLA14-55-□	9.7 ms	21.8 ms	77 mA	113 mA
SFL14-63-□	SFLA14-63-□	10.2 ms	23.0 ms	79 mA	116 mA
SFL14-71-□	SFLA14-71-□	10.7 ms	24.2 ms	80 mA	120 mA
SFL14-79-□	SFLA14-79-□	11.2 ms	25.4 ms	82 mA	124 mA
SFL14-87-□	SFLA14-87-□	11.7 ms	26.6 ms	84 mA	128 mA
SFL14-95-□	SFLA14-95-□	12.2 ms	27.9 ms	85 mA	132 mA
SFL14-103-□	SFLA14-103-□	12.7 ms	29.1 ms	87 mA	135 mA
SFL14-111-□	SFLA14-111-□	13.2 ms	30.3 ms	88 mA	139 mA
	SFLA14-119-□	13.7 ms	31.5 ms	90 mA	143 mA
	SFLA14-127-□	14.2 ms	32.8 ms	92 mA	147 mA
	SFLA14-135-□	14.7 ms	34.0 ms	93 mA	151 mA
	SFLA14-143-□	15.2 ms	35.1 ms	95 mA	154 mA
	SFLA14-151-□	15.7 ms	36.3 ms	96 mA	158 mA
	SFLA14-159-□	16.2 ms	37.6 ms	98 mA	162 mA
	SFLA14-167-□	16.7 ms	38.8 ms	100 mA	166 mA
	SFLA14-175-□	17.2 ms	40.0 ms	101 mA	170 mA
	SFLA14-183-□	17.7 ms	41.2 ms	103 mA	173 mA
	SFLA14-191-□	18.2 ms	42.5 ms	104 mA	177 mA
	SFLA14-199-□	18.7 ms	43.7 ms	106 mA	181 mA

■ Hand detection (SFL(A)20-□-□, Ø 20 mm)

SFL Series	SFLA Series	Response time (ms)		Current consumption (mA)	
		T _{OFF}	T _{ON}	Emitter	Receiver
SFL20-12-□	SFLA20-12-□	7.9 ms	17.3 ms	64 mA	91 mA
SFL20-16-□	SFLA20-16-□	8.4 ms	18.5 ms	65 mA	93 mA
SFL20-20-□	SFLA20-20-□	8.8 ms	19.6 ms	67 mA	95 mA
SFL20-24-□	SFLA20-24-□	9.3 ms	20.7 ms	68 mA	97 mA
SFL20-28-□	SFLA20-28-□	9.8 ms	21.9 ms	69 mA	99 mA
SFL20-32-□	SFLA20-32-□	10.2 ms	23.0 ms	70 mA	102 mA
SFL20-36-□	SFLA20-36-□	10.7 ms	24.1 ms	71 mA	104 mA
SFL20-40-□	SFLA20-40-□	11.1 ms	25.3 ms	72 mA	106 mA
SFL20-44-□	SFLA20-44-□	11.6 ms	26.4 ms	73 mA	108 mA
SFL20-48-□	SFLA20-48-□	12.1 ms	27.5 ms	74 mA	110 mA
SFL20-52-□	SFLA20-52-□	12.5 ms	28.7 ms	75 mA	113 mA
SFL20-56-□	SFLA20-56-□	13.0 ms	29.8 ms	76 mA	115 mA
SFL20-60-□	SFLA20-60-□	13.4 ms	30.9 ms	78 mA	117 mA
SFL20-64-□	SFLA20-64-□	13.9 ms	32.1 ms	79 mA	119 mA
SFL20-68-□	SFLA20-68-□	14.3 ms	33.2 ms	80 mA	121 mA
	SFLA20-72-□	14.8 ms	34.3 ms	81 mA	124 mA
	SFLA20-76-□	15.2 ms	35.5 ms	82 mA	126 mA
	SFLA20-80-□	15.7 ms	36.6 ms	83 mA	128 mA
	SFLA20-84-□	16.2 ms	37.7 ms	84 mA	130 mA
	SFLA20-88-□	16.6 ms	38.9 ms	85 mA	132 mA
	SFLA20-92-□	17.1 ms	40.0 ms	86 mA	135 mA
	SFLA20-96-□	17.5 ms	41.1 ms	87 mA	137 mA
	SFLA20-100-□	17.9 ms	42.2 ms	89 mA	139 mA
	SFLA20-104-□	18.3 ms	43.4 ms	90 mA	141 mA
	SFLA20-108-□	18.7 ms	44.5 ms	91 mA	143 mA
	SFLA20-112-□	19.0 ms	45.6 ms	92 mA	146 mA
	SFLA20-116-□	19.3 ms	46.8 ms	93 mA	148 mA
	SFLA20-120-□	19.6 ms	48.3 ms	94 mA	150 mA
	SFLA20-124-□	19.9 ms	49.7 ms	95 mA	152 mA

■ Hand-Body detection (SFL(A)30-□-□, Ø 30 mm)

SFL Series	SFLA Series	Response time (ms)		Current consumption (mA)	
		T _{OFF}	T _{ON}	Emitter	Receiver
	SFLA30-9-□	8.1 ms	17.7 ms	64 mA	91 mA
	SFLA30-12-□	8.6 ms	18.9 ms	65 mA	93 mA
	SFLA30-15-□	9.1 ms	20.1 ms	67 mA	95 mA
	SFLA30-18-□	9.5 ms	21.3 ms	68 mA	97 mA
	SFLA30-21-□	10.0 ms	22.5 ms	69 mA	99 mA
	SFLA30-24-□	10.5 ms	23.7 ms	70 mA	102 mA
	SFLA30-27-□	11.0 ms	24.9 ms	71 mA	104 mA
	SFLA30-30-□	11.4 ms	26.1 ms	72 mA	106 mA
	SFLA30-33-□	11.9 ms	27.2 ms	73 mA	108 mA
	SFLA30-36-□	12.4 ms	28.4 ms	74 mA	110 mA
	SFLA30-39-□	12.9 ms	29.6 ms	75 mA	113 mA
SFL30-42-□	SFLA30-42-□	13.4 ms	30.8 ms	76 mA	115 mA
SFL30-45-□	SFLA30-45-□	13.9 ms	32.0 ms	78 mA	117 mA
SFL30-48-□	SFLA30-48-□	14.3 ms	33.2 ms	79 mA	119 mA
SFL30-51-□	SFLA30-51-□	14.8 ms	34.4 ms	80 mA	121 mA
SFL30-54-□	SFLA30-54-□	15.3 ms	35.6 ms	81 mA	124 mA
SFL30-57-□	SFLA30-57-□	15.8 ms	36.8 ms	82 mA	126 mA
SFL30-60-□	SFLA30-60-□	16.3 ms	37.9 ms	83 mA	128 mA
SFL30-63-□	SFLA30-63-□	16.7 ms	39.1 ms	84 mA	130 mA
SFL30-66-□	SFLA30-66-□	17.2 ms	40.3 ms	85 mA	132 mA
SFL30-69-□	SFLA30-69-□	17.7 ms	41.5 ms	86 mA	135 mA
SFL30-72-□	SFLA30-72-□	18.2 ms	42.7 ms	87 mA	137 mA
SFL30-75-□	SFLA30-75-□	18.6 ms	43.9 ms	89 mA	139 mA

Functions

■ Safety-related functions

• Interlock

Interlock is safety-related function, when OSSD output is switched to OFF state due to power on or, blocked beams or an error occurs during operation, keeping its OFF state when the beams are clear or the error is fixed. The interlock is reset by auto-reset or manual reset.

• Lockout reset

Lockout means that if an error occurs during self-test or operation, OSSD output goes to OFF state within the response time and maintains it.

After fixing the cause of the error, power on again or apply the reset input for more than 1 second. Then the light curtain performs self-test. If there is no error after the test, the lockout condition is released.

Depending on the cause of the error, the lockout condition may not be released.

If the lockout condition is not released by the reset input, power on again.

• External Device Monitoring (EDM)

This function monitors the state of external devices (e.g. safety relay, connectors, etc) connected to the OSSD output.

• Muting

In the muting condition, the OSSD output maintains ON state regardless of the object in the muting zone. You can set the muting zone as an entire or part of the detection zone.

• Override

Muting function ends due to the muting conditions, and OSSD outputs go to OFF, but resulting in an object in the detection zone. The override function is used to clear the detection zone; the OSSD outputs are switched to ON, and it deliberately removes the object.

• Blanking

If an attached or fixed object is in the detection zone, resulting in the OFF state of OSSD continuously, you can set the blocked beams as a blanking zone. The blanking function will not detect an object and allows the OSSD output to be maintained ON state.

You can use the fixed blanking function when a fixed object or materials continuously blocks certain beams of the light curtain. If the location of a moving object is changing, use the floating blanking function.

• Reduced resolution

Reduced resolution is a function that changes the detection capability of the light curtain. Even if the light curtain is blocked by the moving objects with a diameter smaller than the changed detection capability are ignored in the detection zone, resulting in the OSSD output is maintained ON state. The number of ignored beams can be set from 1 to 3 beams.

■ General functions

• Self-test

This function diagnoses an internal error of the light curtain.

Self-test is performed once within 2 seconds when power is on. Periodic self-test is performed during operation; it completes within the response time. The error is displayed on the status indicators and 7-segment LEDs.

• Alarm for incident light level

The received signal is divided into three areas (stable light ON, unstable light ON, and stable light OFF) based on the light incident level as follows.

The light incident level determines either OSSD output is ON or OFF and the OSSD indicators display the condition. And 7-segment indicator displays the level of the lowest light receiving beam (0 to 9 levels). The amount of received light may decrease due to the product distortion or long-term use. If the amount of received light, even one beam, decreases less than from 15 to 35% and lasts for more than 30 minutes, the alarm for the sensitivity reduction occurs.

- Mutual interference prevention

When you install more than two products, there is a risk of mutual interference. Change the frequency to prevent this interference. Change to frequency A or B using setting switch or atLightCurtain. If you change the frequency, the response time may be changed and affect original response time.

Other functions

- Series connection

If you need to extend the detection zone, connect the light curtains via series connection cable to use two or more emitter and receivers as one product.

It can be extended up to max. 3 sets / 300 beams for SFL and up to max. 4 sets / 400 beams for SFLA. The operation and control of light curtains in series connection are synchronized with the settings of the master. For example, if any light curtain is blocked, the OSSD outputs of all light curtains are switched to OFF state.

- Change sensing distance

It is the function to change the sensing distance to meet installation environment.

If you change the sensing distance, there is an effect to mutual interference.

Mode	Detection capability	Sensing distance
Short mode	Ø 14 mm (Finger)	0.2 to 5 m
	Ø 20 mm (Hand), Ø 30 mm (Hand-Body)	0.2 to 8 m
Long mode	Ø 14 mm (Finger)	0.2 to 10 m
	Ø 20 mm (Hand), Ø 30 mm (Hand-Body)	0.2 to 15 m

- Set NPN or PNP

You can switch between NPN and PNP of the control output (OSSD) of the product and non-safety outputs (AUX 1/2, LAMP 1/2) via the setting switch or atLightCurtain. The ON or OFF state of the input is determined by the settings.

- External test (stop transmission)

The external test is a function for; When the test signal is applied from the outside of the light curtain, it forcibly stops light emission and checks whether the safety system stops correctly. If the light emission stops, the light curtain is blocked, resulting in OSSD output is switched to the OFF state until the test input is released. The emitter operates again when the test input is released. If the restarted interlock is activated, entering interlock condition. If the restarted interlock is activated, entering interlock condition.

- Non-safety output (auxiliary output, AUX 1 / 2)

The auxiliary output is an optional output for monitoring the status of the light curtain. It is provided at the bottom of the emitter and receiver. This output cannot be deactivated. Do not use the auxiliary output for safety purposes.

- Non-safety output (lamp output, LAMP 1 / 2)

The lamp output is provided at the top of the emitter and receiver. After removing the end cap, the dedicated cable can be connected. To activate the lamp output, you must remove the end cap. Do not use the lamp output for safety purposes.

Combination of functions

	Interlock	Reset-hold	EDM	Muting	Override	Fixed blanking	Floating blanking	Reduced Resolution
Interlock	○	○ ⁰¹	○	○	○	○	○	○
Reset-hold	○ ⁰¹	○	○	× ⁰²	× ⁰²	× ⁰³	× ⁰³	○
EDM	○	○	○	○	○	○	○	○
Muting	○	× ⁰²	○	○	○	○ ⁰⁴	○ ⁰⁴	×
Override	○	× ⁰²	○	○	○	○	○	×
Fixed blanking	○	× ⁰³	○	○ ⁰⁴	○	○	○ ⁰⁵	×
Floating blanking	○	× ⁰³	○	○ ⁰⁴	○	○ ⁰⁵	○	×
Reduced Resolution	○	○	○	×	×	×	×	○

01) The reset-hold function is available only when the manual reset is activated.

02) The auxiliary output of emitter (AUX2) and reset-hold functions are not available when the muting or override is activated.

03) The functional combination of the reset-hold with fixed blanking and floating blanking is unavailable.

04) Both the muting zone and blanking zone can be set simultaneously.

05) Both Functions, fixed blanking and floating blanking, are simultaneously configurable, but a zone where the two functions overlap cannot be set.

Glossary

- The gray area is the detection zone.

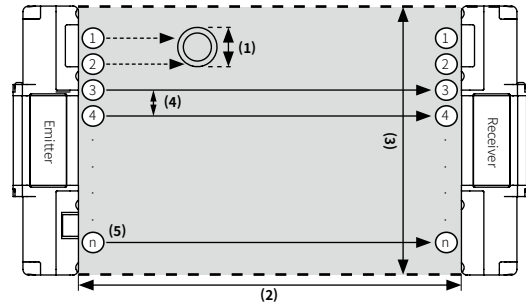

- (1) Detection capability : The minimum diameter of the detectable cylindrical object (mm).
- (2) Sensing distance : The maximum distance between the emitter and receiver that can detect an object with the minimum detection capability.
- (3) Protective height : The height at which the minimum detection object can be detected in the direction of the optical axis.
- (4) Optical axis pitch: Distance between the optical axis and the next optical axis (mm).
- (5) Number of beams : Number of optical axes that consist of the emitter and receiver. (same as emitter and receiver)

How to Install and Adjust Your Light Curtain

Install

01. Place the bracket in the position where the light curtain will be installed and install the emitter and the receiver face to each other.

Use suitable brackets meeting each method of mounting. The type and number of brackets differ depending on the length of the light curtain.

02. Power on the light curtain.

03. Adjust the top and bottom beam of the light curtain to meet the centerline.

If the top and bottom beams are aligned, the indicator lights up.

You can monitor the light incident level via atLightCurtain.

04. If all beams are clear, tighten the bracket screws to fix it.

- If the beams are unstable because the beams are not completely aligned, the top beam and bottom beam indicators flash every 1 second. If the beams are blocked, the indicators light off.
- Do not install the light curtain in a place that is exposed directly to fluorescent lamps operating with a quick start or high frequency.

Safety distance

A safety distance is a minimum distance that a machine stops before the human or object approaches to hazards.

If you do not consider the safety distance when installing the light curtain, the machine may not stop before the human reaches hazards so that it may result in personal injury. The safety distance calculation may differ from laws, regulations, and standards. Therefore, be sure to use the appropriate formula which abides by the rules of the country.

Safety distance according to ISO 13855 (EN ISO 13855, KS C 13855) (basic formula)

$$S = K \times T + C$$

- Safety distance (S) : minimum distance from the detection zone to the hazards
- Approach speed (K) : The human approach speed in the detection zone
- The total stopping time of entire system (T) : $T = t_1 + t_2$
(t_1 : the product response time (T_{OFF}), t_2 : response time of the safety system)
- Additional distance (C) : Additional distance calculated from the detection capability

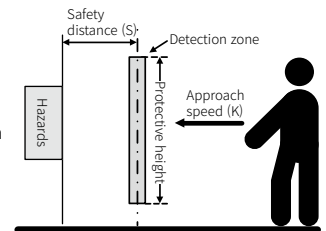

IP67G (JEM standard)

Used oil (for reference only)

Oil type	JIS standard	Oil name	Kinetic viscosity (mm ² /s, 40 °C)	PH
Lubricating oil	—	Velocite Oil No.3	2	—
Water-insoluble cutting fluid	2-5	Tectyl Cut 527	27	—
Water-soluble cutting fluid	—	Tectyl Cool 263C	—	9.5 (10 % Solution)

- IP67G means oil (drops and powders) from all directions completely blocked. It obtains the protection rating of enhanced oil resistance. (Pass the dropping test for 48 hours with the above oil)

Sold Separately: Brackets

- Tighten the brackets screws with a torque of 0.98 N m.
- Unit: mm, For the detailed drawings, follow the Autonics website.

■ Top / Bottom adjustable bracket (BK-SFL-TBA)

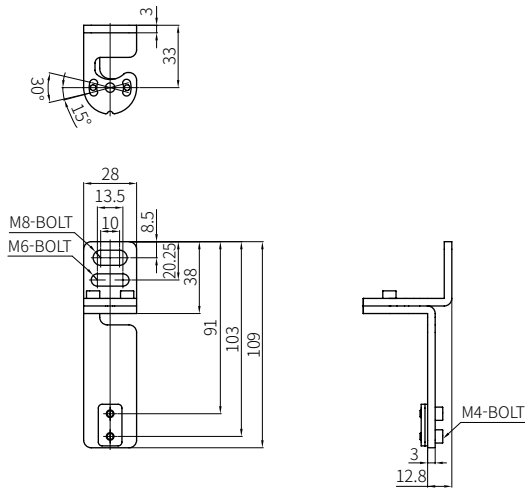

■ Top / Bottom bracket (BK-SFL-TBF)

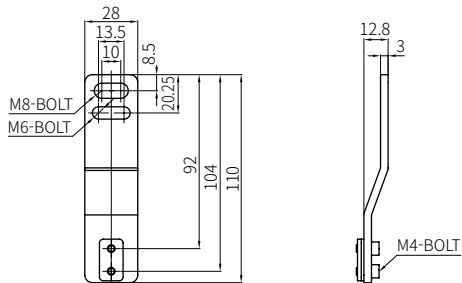

■ Side adjustable bracket (BK-SFL-SA)

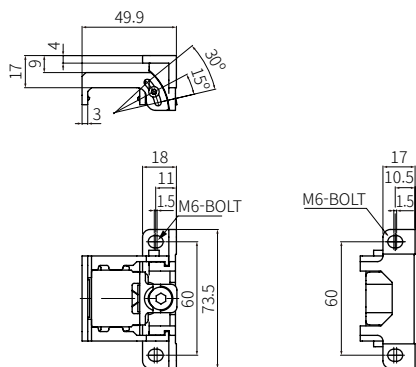

■ Side bracket (BK-SFL-SF)

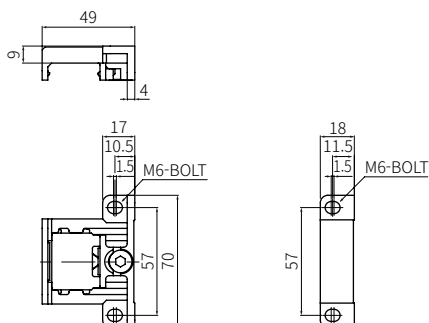

Sold Separately: Power I/O Cable

- Cable material: polyurethane (PUR) or polyvinyl chloride (PVC), cable color: black
- Tighten the connecting cable screws with a torque of 0.59 N m.
- Refer to the connector cable for the color of wire.
- Unit: mm, For the detailed drawings, follow the Autonics website.

■ Connector type

- PUR

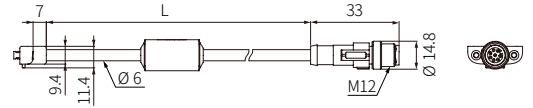
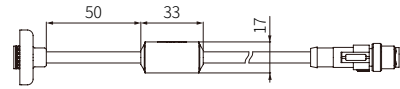

- PVC

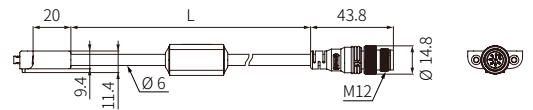
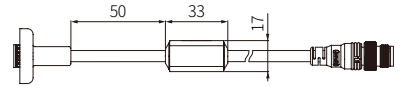

Model		Length (L)
Emitter	Receiver	
SFL-BCT	SFL-BCR	0.3 m

■ Wire type

- PUR

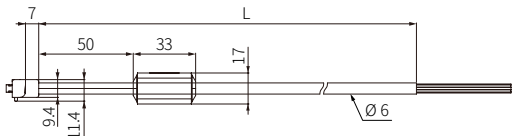

- PVC

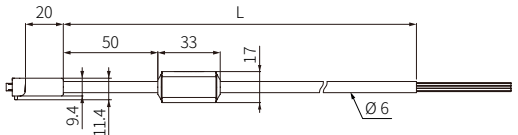

Model		Length (L)
Emitter	Receiver	
SFL-C3T	SFL-C3R	3 m
SFL-C7T	SFL-C7R	7 m
SFL-C10T	SFL-C10R	10 m
SFL-C15T	SFL-C15R	15 m

Sold Separately: M12 Connector Cable

- Cable material: polyurethane (PUR) or polyvinyl chloride (PVC), cable color: black
- Unit: mm, For the detailed drawings, follow the Autonics website.
- Tighten the connecting cable screws with a torque of 0.59 N m.

Pin No.	Color	Emitter (black)	Receiver (black)
1	Blue	0 V	0 V
2	Orange	Reset hold input / Mute 1 input	EDM input
3	Yellow	RS485(B)	RS485(B)
4	Red	RS485(A)	RS485(A)
5	Pink	AUX 2 output / Mute 2 input	AUX 1 output
6	Black	External test input	OSSD 1 output
7	White	Reset input	OSSD 2 output
8	Brown	+24 VDC==	+24 VDC==

■ Socket type

- PUR

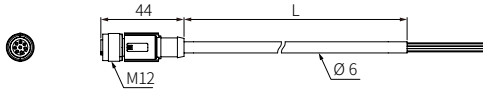

- PVC

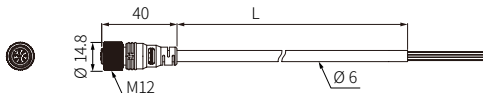

Model		Length (L)
Emitter	Receiver	
C1D8-3T	C1D8-3R	3 m
C1D8-5T	C1D8-5R	5 m
C1D8-7T	C1D8-7R	7 m
C1D8-10T	C1D8-10R	10 m

■ Socket-plug type

- PUR

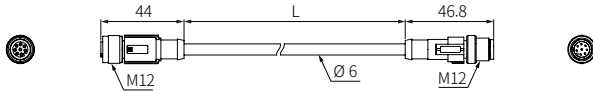

- PVC

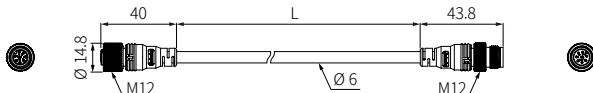

Model		Length (L)
Emitter	Receiver	
C1D8-3T	C1D8-3R	3 m
C1D8-5T	C1D8-5R	5 m
C1D8-7T	C1D8-7R	7 m
C1D8-10T	C1D8-10R	10 m
C1D8-15T	C1D8-15R	15 m
C1D8-20T	C1D8-20R	20 m

Sold Separately: Y Type Connector Cable

- Cable material: polyvinyl chloride (PVC), cable color: black
- Tighten the connecting cable screws with a torque of 0.59 N m.
- Unit: mm, For the detailed drawings, follow the Autonics website.

■ Connector cable for reducing wires (SFL-YC)

- Auxiliary output 1 (AUX1) and external test inputs are not available when using the Y type connector cable.

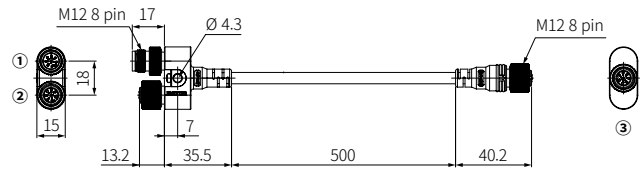

Pin no	Color	① Power connection ⁰¹⁾	② Emitter ⁰²⁾	③ Receiver ⁰³⁾
1	Blue	0 V	0 V	0 V
2	Orange	EDM input	Reset hold input / Mute 1 input	EDM input
3	Yellow	Reset input	RS485 (B)	RS485 (B)
4	Red	Reset hold input / Mute 1 input	RS485 (A)	RS485 (A)
5	Pink	AUX 2 output / Mute 2 input	AUX 2 output / Mute 2 input	AUX 1 input
6	Black	OSSD 1 output	External test input	OSSD 1 output
7	White	OSSD 2 output	Reset input	OSSD 2 output
8	Brown	+24 VDC==	+24 VDC==	+24 VDC==

01) Use the connector cable (socket type, CID8-□T(R)) for the emitter or receiver to connect with a voltage source.

02) Use the power I/O cable (connector type, SFL-BCT) for the emitter to connect with the product.

03) Use the power I/O cable (connector type, SFL-BCR) for the receiver to connect with the product.

■ Reset switch connector cable (SFL-YCR)

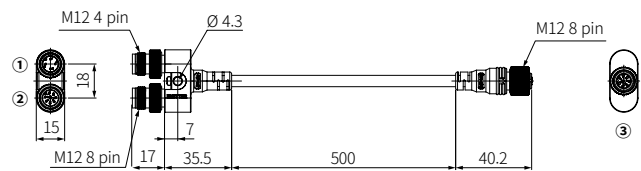

Pin no	Color	① Reset input	Color	② Emitter ⁰¹⁾	③ Emitter ⁰²⁾
1	Brown	+24 VDC==	Blue	0 V	
2	White	Reset input	Orange	Reset hold input / Mute 1 input	
3	Blue	0 V	Yellow	RS485 (B)	
4	Black	AUX 2 output	Red	RS485 (A)	
5			Pink	AUX 2 output / Mute 2 input	
6			Black	External test input	
7			White	Reset input	
8			Brown	+24 VDC==	

01) Use the connector cable (socket type, CID8-□T) for the emitter to connect with the receiver.

02) Use the power I/O cable (connector type, SFL-BCT) for the emitter to connect with the product.

Sold Separately: Series Connection Cable

- Cable material: polyurethane (PUR), cable color: black
- Tighten the connecting cable screws with a torque of 0.59 N m.
- Unit: mm, For the detailed drawings, follow the Autonics website.

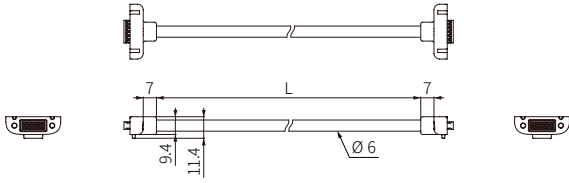

Model		Length (L)
Emitter	Receiver	
SFL-EC03T	SFL-EC03R	0.3 m
SFL-EC3T	SFL-EC3R	3 m
SFL-EC7T	SFL-EC7R	7 m
SFL-EC10T	SFL-EC10R	10 m

Sold Separately: Lamp Output Cable

- Cable material: polyurethane (PUR), cable color: black
- Tighten the connecting cable screws with a torque of 0.59 N m.
- Unit: mm, For the detailed drawings, follow the Autonics website.

■ SFL-LC

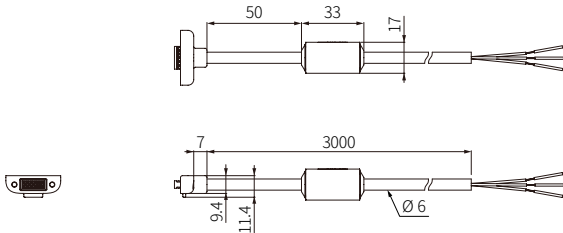

Color	Function
Blue	0 V
Brown	+24 VDC
Black	Lamp output

Sold Separately : SFL / SFLA dedicated USB to Serial Communication Converter

- Unit: mm, For the detailed drawings, follow the Autonics website.

■ SCM-SFL

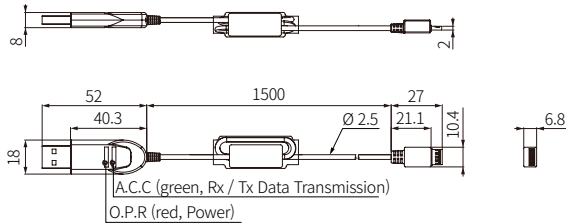

Sold Separately: Test piece

- Unit: mm, For the detailed drawings, follow the Autonics website.
- The test piece is a black opaque object.

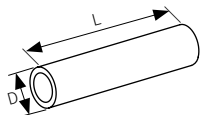

Model	Diameter (D)	Length (L)
SFL-T14	Ø 14 mm	200 mm
SFL-T20	Ø 20 mm	
SFL-T30	Ø 30 mm	