



# PL4 Series

Ø45mm LED Steady & Flashing



- Pre-assembled 1 to 5 stack lights
- High visibility from every angle
- through prism-cut lens
- Built-in buzzer available (75±5dB)
- Various mounting options
- Cost effective type

## Specifications

Current Draw	Power Supply	12~24VAC/DC		110~220VAC	
	Model	Standard type	with Buzzer type	Standard type	with Buzzer type
1 Stack		0.22A	0.25A	0.03A	0.03A
2 Stack		0.30A	0.32A	0.05A	0.06A
3 Stack		0.38A	0.38A	0.07A	0.07A
4 Stack		0.46A	0.46A	0.19A	0.09A
5 Stack		0.52A	0.52A	0.11A	0.11A
LED Function		Steady + Flashing			
Operation Voltages		12~24VAC/DC, 110~220VAC (AC 50/60Hz)			
Light Source		LED			
LED Colours		5 Colors – Red, Yellow, Green, Blue, White			
Dimensions / Tiers		D45mm / up to 5 Tiers			
Flashing rates		12VDC - 75±5times/minute			
		12VAC, 24VAC/DC - 80±5times/minute			
		90~240VAC - 80±5times/minute			
Alarm sound level		75±5dB- at 1M			
Lens Color		5 Colors – Red, Yellow, Green, Blue, Clear			
Mounting		Upward only			
Wiring Method		Lead wires			
Ambient Temperature		-20 ~ 40°C			
Storage Temperature		-20 ~ 70°C			
Ambient Humidity		45~85% RH			
Dielectric Strength		1000VAC 50/60Hz for 1min			
Insulation Resistance		100MΩ min. at 500VDC			
Vibration		0.75mm at 10~55Hz			
Recommended Wire Size		UL1007 / 22AWG			
Certificate/compliance		UL(excl. 220 VAC), CE(DC only), RoHS			
Degree of Protection		IP65 (Buzzer type : IP52)			

## Ordering Information

PL4 C B - 3 00 - RYG - W  
 ① ② ③ ④ ⑤ ⑥

① Mounting Type	no mark	Pole/Surface Mounting
	<b>C</b>	Direct Mounting
② Light Function	no mark	Steady
	<b>B</b>	Steady + Buzzer
	<b>F</b>	Steady + Flashing
	<b>Z</b>	Steady + Flashing + Buzzer
③ Number of Stacks	<b>1</b>	1 Light
	<b>2</b>	2 Lights
	<b>3</b>	3 Lights
	<b>4</b>	4 Lights
	<b>5</b>	5 Lights
④ Power Supply	<b>00</b>	12~24VAC/DC
	<b>FF</b>	110~220VAC
⑤ LED Color*	<b>R</b>	Red
	<b>RG</b>	Red +Green
	<b>RYG</b>	Red +Yellow + Green
	<b>RYGB</b>	Red +Yellow + Green + Blue
	<b>RYGBC</b>	Red +Yellow + Green + Blue + Clear
⑥ Lens Color	no mark	Color Lens
	<b>W</b>	All White Lens

\* Other color configurations are available with special order

unit: mm

Stacks	L1	L2
1	132	137
2	162	167
3	192	217
4	222	227
5	252	257

## Dimensions

unit: mm

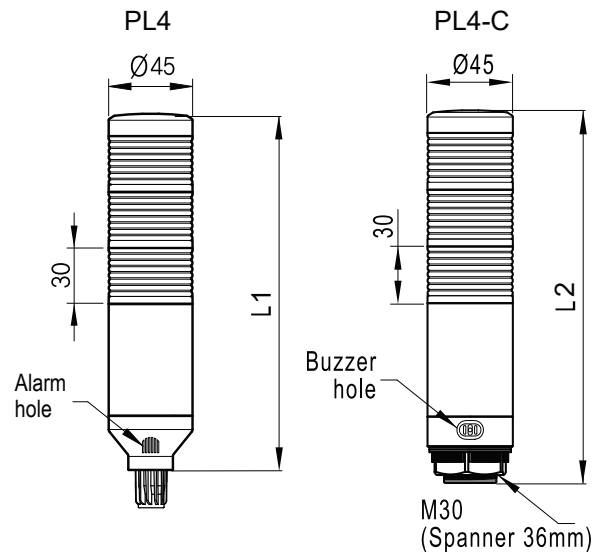

# Mounting Options

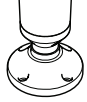
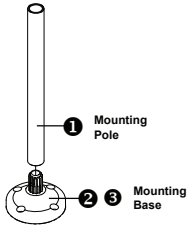
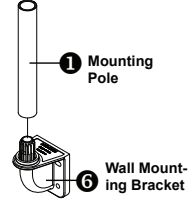
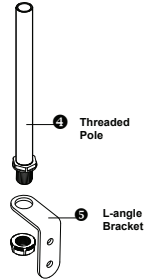
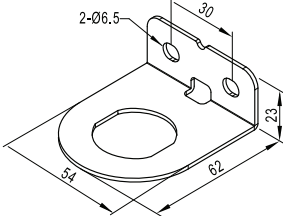
Light Series	Mounting Type	Mounting Parts		Mounting Example	
PL4	Surface Mounting	Mounting Base			
		MAM-B070F			
	"Pole Mounting + Wall Mounting"	Pole Mounting	Mounting Pole	Mounting Base	
			MAP-0060 (L: 60mm) MAP-0240 (L: 240mm) MAP-0750 (L: 750mm) MAP-1000 (L: 1,000mm)	MAM-B090C (Plastic) MAM-DS32A (Aluminum) MAM-B070R (Plastic, Folding) MAM-470R-20 (Plastic, Folding) MAM-DS42R-20C (Aluminum, Folding)	
		Mounting Pole	Wall Mounting Bracket		
	MAP-0060 (L: 60mm) MAP-0240 (L: 240mm) MAP-0750 (L: 750mm) MAP-1000 (L: 1,000mm)	MAP-DS40 (Plastic)			
"Pole Mounting + Wall Mounting"	"Pole Mounting + Wall Mounting"	Mounting Pole	Wall Mounting Bracket		
		MAP-M043 (L: 43mm, M20 Nut) MAP-M240 (L: 240mm, M20 Nut) MAP-M750 (L: 750mm, M20 Nut) MAP-M1000 (L: 1,000mm, M20 Nut)	MAM-DS25 (L-angle, Metal)		
PL4-C	Wall Mounting	Wall Mounting Bracket			
MAM-DS43					

# Wiring Diagram

Steady , Steady + Buzzer

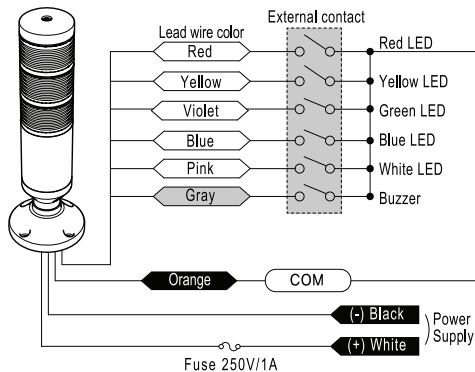

Steady + Flashing , Steady + Flashing + Buzzer

