

SECTION A-A

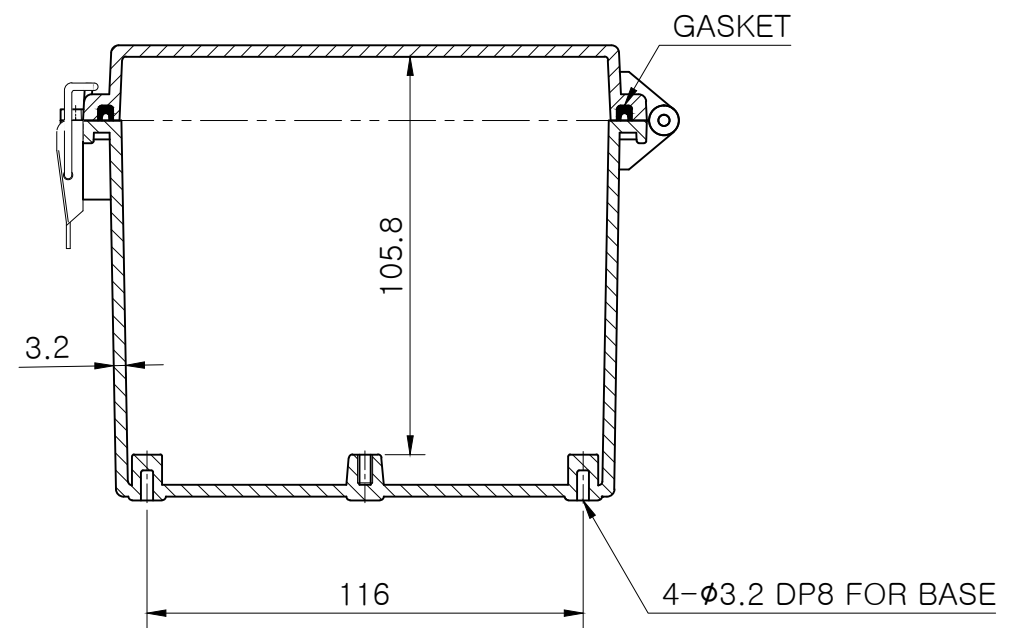
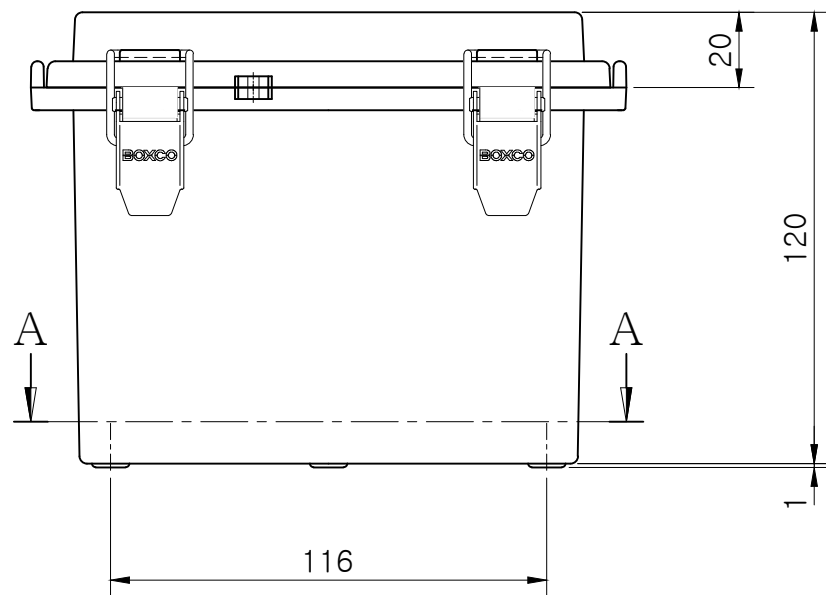

SECTION B-B

Note.

MODEL (모델)	BC-□□P-151512		D R (재도)	JUNG, Y.J.	16.04.05	UNIT (단위)	mm
ASSY (완성 규격)	150 * 150 * 120		C K (검도)	PARK, Y.J.	16.04.05	SCALE (척도)	1:2
DWG NO (도번)	P-151512-03	MATERIAL (재질)	A P (승인)	KIM, D.S.	16.04.06	REV. (개정)	0

