

MSP Series

Panel/Wall Mount Buzzer



Ordering Information

MSP - T P M - 02 (B)
 ① ② ③ ④ ⑤

① Connection	T	Terminal Type
	L	Lead Wire Type
② Mounting	P	Panel Mounting
	B	External Fixation Type
③ Sound Type	M	Melody 3 channel
	S	Siren 3 channel
④ Rated Voltage	01	12VDC
	02	24VDC
	FF	100 ~ 240VAC
⑤ Body Colors	no mark	Ivory
	(B)	Black
	(R)	Red

Specifications

Model	MSP-T	MSP-L
Power Supply	12 VDC, 24VDC, 100~240 VAC	
Current Consumption	12VDC Melody type: 0.22A Siren type: 0.8A 24VDC Melody type: 0.12A Siren type: 0.4A 100~240VAC Melody type: 0.13A Siren type: 0.13A	
Maximum Volume	Melody type: 100±5dB(1M), Siren type: 110±5dB(1M)	
Number of Channels	Sound types: 3 channels	
Sound Type	Melody type: For Elise, Sweet Home, Cuckoo Waltz Siren type: Fire Truck, Police Car, Ambulance	
Volume Control	Built-in volume control	None
Color	Body - Ivory/Black/Red, Horn speaker - Black	
Material	Body - ABS, Horn - NBR	
Insulation resistance	Over 100MΩ (500VDC mega btwn terminal and case)	
Withstand voltage	500VAC 50/60Hz 1 min.	
Temperature	Working temp.: - 20 ~ 50°C Storage temp.: - 20 ~ 65°C	
Operating humidity	45 ~ 85% RH	
Degree of protection	IP65 (Front panel)	
Wire Size	-	2464UL/22AWG, 6P, 450mm
Certificate	RoHS	
Weight	436g (MSP-TP type)	588g (MSP-LB type)

How to install

MSP-TP, MSP-LP Type

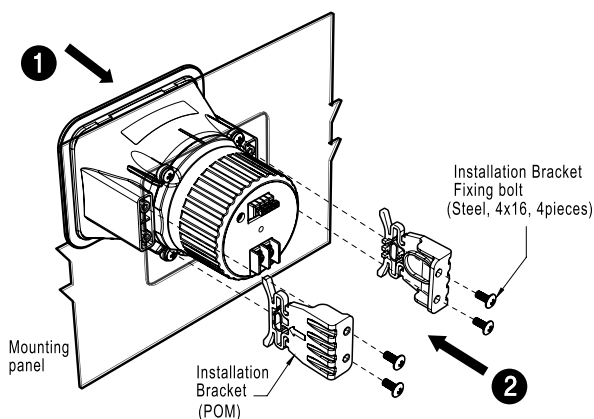

1. Remove the installation bracket and bolts with a screwdriver from the product.
2. Insert the speaker in the direction of ① on the panel.
3. Mount the installation bracket to the direction of ② and fix with fixing bolt to prevent from shaking.

MSP-TB, MSP-LB Type

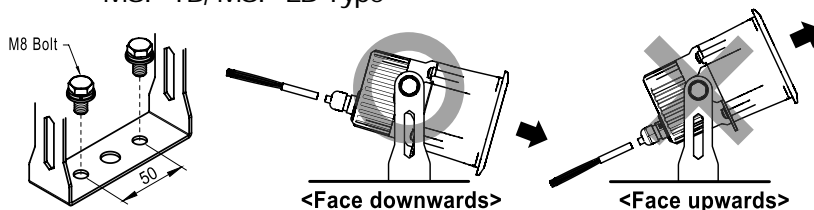

1. Fixed using M8 bolts in the hole of the angle adjusting holder. Do not fail to apply vibration absorbing rubber when installing in the place with strong vibration.
2. Please install downwards when installing outdoors to prevent rainwater from entering in the device.
3. Set the speaker angle and then fasten the angle adjustment bolt tight. (Tightening torque: 5 ~ 6N.m)

Accessories

- Each two bolts and nuts to fix M8 are packaged.

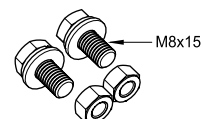

Dimensions

(Unit: mm)

MSP-TP Type

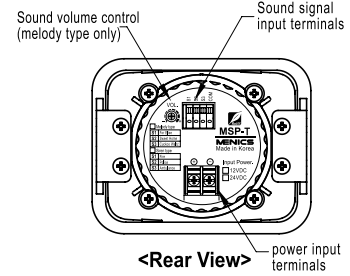
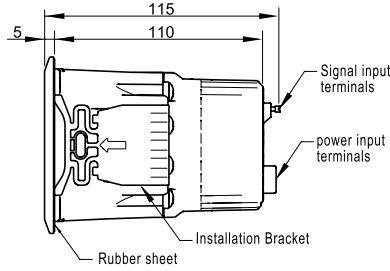
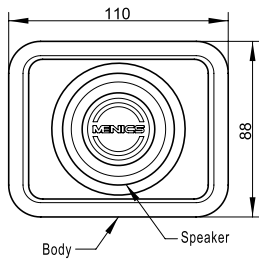

MSP-LP Type

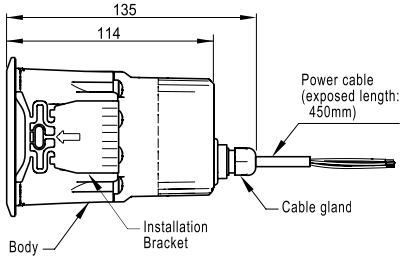

MSP-LB Type

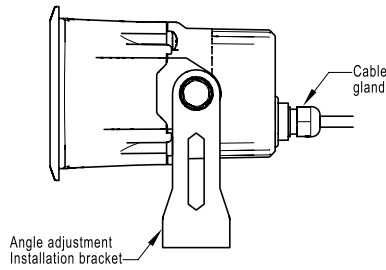

Panel cutout dimensions

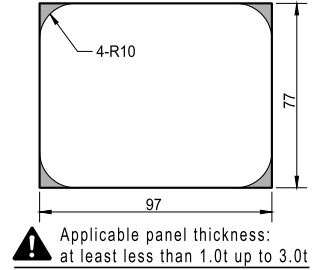

MSP-TB Type

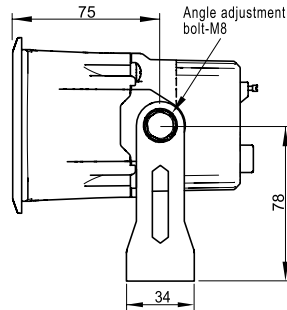
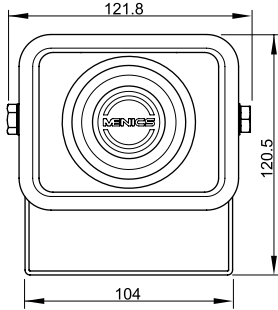

Wiring Diagram

● MSP-T series Connection diagram

• Power input terminals

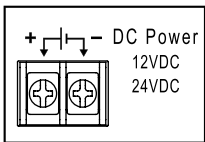

※ It is recommended to lead wire short to reduce noise and use shield wire.

• Specification of crimp terminal

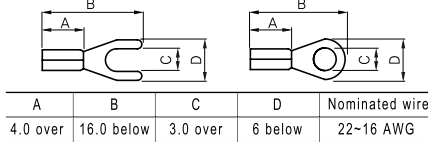

● MSP-L series Wiring Diagram



- Connect the power same as indicated in the product. Otherwise, over current may cause a failure of the product.
- Do not apply power to the sound color signal line and COM line. Short circuit and over current may cause a failure of the product.

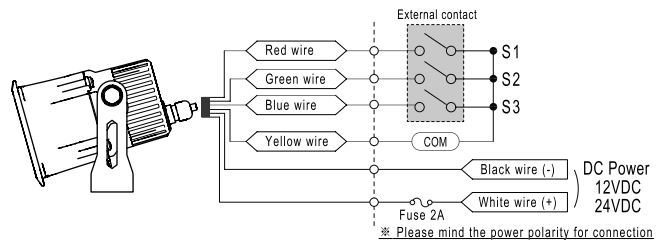

No	Wire color	Melody type	Siren type
S1	Red	for Elise	Fire truck
S2	Green	Sweet home	Police car
S3	Blue	Cuckoo Waltz	Ambulance

▲ Caution

- ※ Connect external fuse between the product and the power supply to protect internal circuitry. Siren type: 2A Melody type: 0.5A
- ※ Please isolate the signal line that is not in use. There is a risk of electric shock.

※ External dimension and the performance is subject to change without prior notice to improve the product.

• Sound signal input terminals

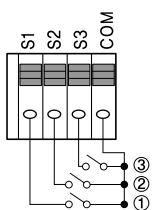

※ Connect signal wire to COM terminal of sound color input terminal and to the terminal of the selected sound type.

No	Terminals	Melody type	Siren type
①	COM - S1	for Elise	Fire truck
②	COM - S2	Sweet home	Police car
③	COM - S3	Cuckoo Waltz	Ambulance

※ Do not put power to the sound color signal input terminal. There is a risk of damage to the circuit if powered.

• Volume control

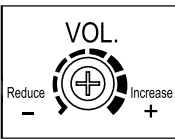

▼ How to connect signal cable

1. Press the lever of the terminal with a small screw driver.
2. Insert peeled off signal cable into terminal hole.
3. Release pressing lever.

▲ Caution

- ※ Keep the length of peeled off signal cable. If the length of peeled off signal cable is too short, there is a risk of malfunction due to connection error and if too long, it may cause electric shock or short circuit.
- ※ Do not pull out signal cable to remove. There is a risk of damage to the terminal. Do not fail to remove by handling the lever of the terminal.

